



OPERATING INSTRUCTIONS

EN

Translation of the Original

ASM 306S

Leak detector

PFEIFFER  **VACUUM**

Disclaimer of liability

These operating instructions describe all models and variants of your product. Note that your product may not be equipped with all features described in this document. Pfeiffer Vacuum constantly adapts its products to the latest state of the art without prior notice. Please take into account that online operating instructions can deviate from the printed operating instructions supplied with your product.

Furthermore, Pfeiffer Vacuum assumes no responsibility or liability for damage resulting from the use of the product that contradicts its proper use or is explicitly defined as foreseeable misuse.

Copyright

This document is the intellectual property of Pfeiffer Vacuum and all contents of this document are protected by copyright. They may not be copied, altered, reproduced or published without the prior written permission of Pfeiffer Vacuum.

We reserve the right to make changes to the technical data and information in this document.

Table of contents

1	About this manual	6
1.1	Validity	6
	1.1.1 Applicable documents	6
	1.1.2 Products concerned	6
1.2	Target group	6
1.3	Conventions	6
	1.3.1 Pictographs	6
	1.3.2 Instructions in the text	7
	1.3.3 Labels	7
	1.3.4 Abbreviations	8
2	Safety	9
2.1	General safety information	9
	2.1.1 Safety instructions	9
	2.1.2 Precautions	10
2.2	Intended use	11
2.3	Foreseeable misuse	11
3	Transportation and Storage	12
3.1	Receipt of the product	12
3.2	Unpacking/Packing	12
3.3	Handling	13
3.4	Storage	14
4	Product description	15
4.1	Product identification	15
	4.1.1 Scope of delivery	15
4.2	Connection interface	15
4.3	Control panel description	16
4.4	Description of the sniffer probe	16
4.5	Description of calibrated leak	17
5	Installation	18
5.1	Detector installation	18
5.2	Sniffer probe installation	18
5.3	Calibrated leak installation	18
5.4	Electrical connection	19
6	Commissioning	20
6.1	Preliminary precautions for use	20
6.2	Switching the detector on	20
6.3	Detector powering off	20
7	Operation	21
7.1	Prerequisites for optimizing measure	21
7.2	Use conditions	21
7.3	Ambient [He] function	21
7.4	Tightness test procedure	21
7.5	Using the sniffer probe	22
7.6	Operation monitoring	22
7.7	Test Start/Stop	23
7.8	Calibration	23
	7.8.1 External calibration	23
	7.8.2 Calibration on concentration	24
7.9	Zero function	25
7.10	Touch screen	25
	7.10.1 Navigation	26

7.10.2	Main screen (Home)	27
7.10.3	Graph screen	28
7.10.4	Graph screen: graph parameters	29
7.10.5	Graph screen: recording	29
7.10.6	Graph screen: saving a recording	30
7.10.7	Graph screen: viewing a recording	30
7.10.8	Function key bar	32
8	Settings menu	34
8.1	Measure menu	35
8.1.1	Tracer gas	35
8.1.2	Set points	35
8.1.3	Correction factor	38
8.1.4	Calibrated leak reference	39
8.1.5	Target value	40
8.1.6	Calibrated leak setting	40
8.2	Probe menu	41
8.2.1	Probe flow unit	41
8.2.2	Probe clogged	42
8.2.3	ECO mode	42
8.3	Configuration menu	43
8.3.1	Unit/Date/Time/Language	43
8.3.2	Sound volume	44
8.3.3	Screen settings	45
8.3.4	Access - Password	45
8.4	Maintenance menu	47
8.4.1	History	47
8.4.2	Information	49
8.4.3	Last maintenance operations	51
8.4.4	Counters before next maintenance	51
8.4.5	Maintenance turbo pump and cell	51
8.4.6	Import/Export parameters	52
8.5	File Manager menu	52
8.6	Advanced menu	53
8.6.1	Input/Output	54
8.6.2	Service	55
9	Maintenance/Replacement	56
10	Service solutions by Pfeiffer Vacuum	57
11	Accessories	59
12	Technical data and dimensions	60
12.1	General	60
12.2	Technical data	60
12.3	Units of pressure	61
12.4	Gas throughputs	61
12.5	Dimensions	61
13	Appendix	62
13.1	Tree diagram of the Settings menu	62
	UL/CSA compliance	69
	Declaration of conformity	70

List of tables

Tbl. 1:	Coding of the LED display of the sniffer probe	17
Tbl. 2:	Main screen (Home)	28
Tbl. 3:	Graph screen	29
Tbl. 4:	Accessories	59
Tbl. 5:	Technical data	60
Tbl. 6:	Environmental conditions	60
Tbl. 7:	Units of pressure and their conversion	61
Tbl. 8:	Gas throughputs and their conversion	61
Tbl. 9:	Default settings: menu [MEASURE] (1/2)	62
Tbl. 10:	Default settings: menu [MEASURE] (2/2)	63
Tbl. 11:	Default settings: menu [PROBE]	64
Tbl. 12:	Default settings: menu [CONFIGURATION] (1/2)	65
Tbl. 13:	Default settings: menu [CONFIGURATION] (2/2)	65
Tbl. 14:	Default settings: menu [MAINTENANCE]	66
Tbl. 15:	Default settings: menu [FILE MANAGER]	66
Tbl. 16:	Default settings: menu [ADVANCED]	67
Tbl. 17:	Default settings: graph parameters	68

1 About this manual



IMPORTANT

Read carefully before use.
Keep the manual for future consultation.

1.1 Validity

This operating instructions is a customer document of Pfeiffer Vacuum. The operating instructions describe the functions of the named product and provide the most important information for the safe use of the device. The description is written in accordance with the valid directives. The information in this operating instructions refers to the product's current development status. The document shall remain valid provided that the customer does not make any changes to the product.

1.1.1 Applicable documents

Document	Part number
Maintenance instructions - ASM 306S	127443M ¹⁾
Operating instructions - RS-232	122215 ¹⁾
Operating instructions - 37 pin I/O interface (Ethernet + USB)	123894 ¹⁾
Operating instructions - Profibus - Profinet - 15 pin I/O	128328 ¹⁾
Condensed manual - Sniffer probe	127828 ¹⁾
EC Declaration of conformity	Included with this manual
UL/CSA compliance	Included with this manual

¹⁾ also available at www.pfeiffer-vacuum.com

1.1.2 Products concerned

This document applies to products with the following part numbers:

Part Number	Description
RSAS00AxMM9A • x: variable according to the "Interface" option selected	ASM 306S

1.2 Target group

This user manual is intended for all persons in charge of transport, installation, commissioning/decommissioning, use, maintenance or storage of the product.

The work described in this document must only be carried out by persons with suitable technical training (specialized staff) or persons who have undergone Pfeiffer Vacuum training.

1.3 Conventions

1.3.1 Pictographs

Pictographs used in the document indicate useful information.



Note



Tip

1.3.2 Instructions in the text

Usage instructions in the document follow a general structure that is complete in itself. The required action is indicated by an individual step or multi-part action steps.

Individual action step

A horizontal, solid triangle indicates the only step in an action.

- ▶ This is an individual action step.

Sequence of multi-part action steps

The numerical list indicates an action with multiple necessary steps.

1. Step 1
2. Step 2
3. ...

1.3.3 Labels

INPUTS/OUTPUTS	Inputs/Outputs Interface connector
SERIAL	D-Sub 9 pins RS-232 connector
NETWORK	Ethernet plug
USB	USB plug

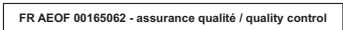
- 

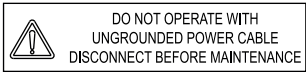
This label guarantees to the user that the product packaging has not been opened since leaving the factory.
- 

This label indicates that some of the internal parts are electrically live and could cause electrical shock in case of contact.

 - Do not use the product if the power cable is not earthed.
 - Disconnect the power cable from the product before servicing the product.
- 

This label indicates that some of the internal parts are electrically live and could cause electrical shock in case of contact.

 - Disconnect the power cable from the product before removing the cover.
- 

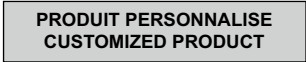
This label indicates the grounding point on the product.
- 

This label indicates that the product has been customized at the customer's request.
- 

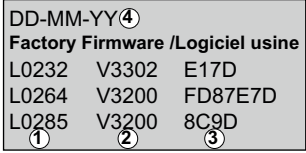
This label indicates that the product has been certified compliant with quality control upon leaving the factory.
- 

This label provides information regarding Firmware installed in the product.

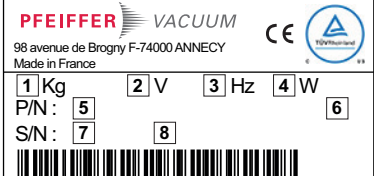
1 Firmware name	3 Firmware checksum
2 Firmware release	4 Publication date
- 

Product rating plate.

1 Weight	5 Part Number
2 Operating voltage	6 Description
3 Operating frequency	7 Serial number
4 Maximum power consumption	8 Date of manufacture



This label indicates that the product is subject to regulations for the treatment of electrical and electronic equipment waste (see the EC declaration of product conformity).

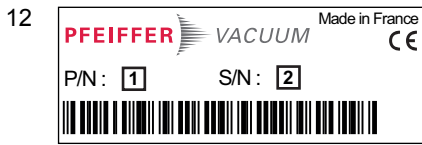

Sniffer probe rating plate (accessory).

1 Part Number 2 Serial number

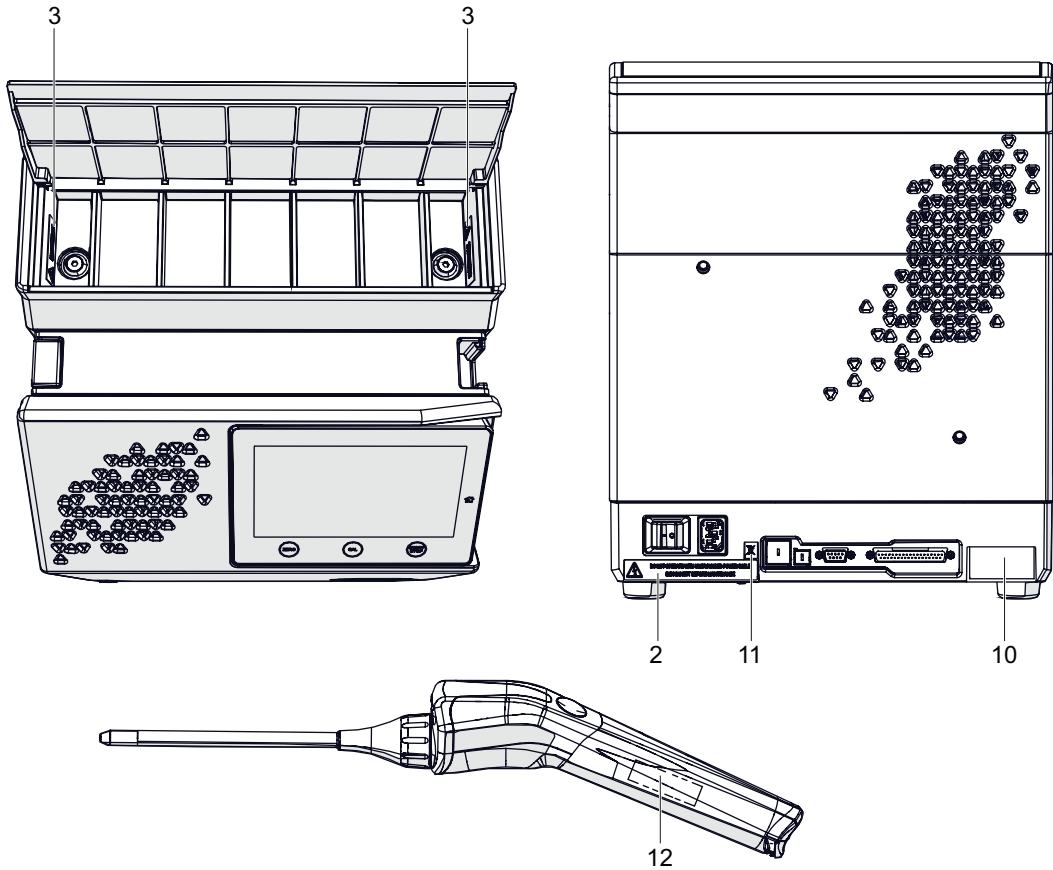

1.3.4 Abbreviations

I/O	Input/Output
⁴ He	Helium 4
³ He	Helium 3
H ₂	Hydrogen
[XXXXXX]	Control panel menus and settings e.g. [Measure] [Tracer Gas] to select the tracer gas used for the test.

2 Safety

2.1 General safety information

The following 4 risk levels and 1 information level are taken into account in this document.

DANGER

Immediately pending danger

Indicates an immediately pending danger that will result in death or serious injury if not observed.

- ▶ Instructions to avoid the danger situation

WARNING

Potential pending danger

Indicates a pending danger that could result in death or serious injury if not observed.

- ▶ Instructions to avoid the danger situation

CAUTION

Potential pending danger

Indicates a pending danger that could result in minor injuries if not observed.

- ▶ Instructions to avoid the danger situation

NOTICE

Danger of damage to property

Is used to highlight actions that are not associated with personal injury.

- ▶ Instructions to avoid damage to property



Notes, tips or examples indicate important information about the product or about this document.

2.1.1 Safety instructions

All safety instructions in this document are based on the results of the risk assessment carried out in accordance with Low-Voltage Directive 2014/35/UE regarding electrical safety. Where applicable, all life cycle phases of the product were taken into account.

WARNING

Risk of electric shock due to non-compliant electrical installations

This product uses mains voltage for its electrical supply. Non-compliant electrical installations or installations not done to professional standards may endanger the user's life.

- ▶ Only qualified technicians trained in the relevant electrical safety and EMC regulations are authorized to work on the electrical installation.
- ▶ This product must not be modified or converted arbitrarily.

WARNING

Risk of electric shock in case of contact with products that are not electrically isolated

When powering off _mains switch to **O**_, certain components located between the mains connection and the circuit breaker will still contain an electric charge (live). There is a risk of electric shock in case of contact.

- ▶ Make sure that the mains connection is always visible and accessible so that it can be unplugged at any time.
- ▶ Disconnect the mains cable from the electrical network before working on the product.
- ▶ Wait for the control panel screen to turn off completely before working on the product and/or removing the cover(s).

⚠ WARNING

Health risk related to residual traces on the parts tested

A leak detection operation must be carried out under environmental conditions that do not present any risks to the operator and the equipment. The user and/or integrator of the product are fully responsible for the operational safety conditions of the equipment.

- ▶ Do not test parts or equipment with traces of harsh, chemical, corrosive, inflammable, reactive, toxic, or explosive substances, nor condensable vapors, even in small amounts.
- ▶ Apply the relevant safety instructions in accordance with local regulations.

⚠ WARNING

Risk of serious injury due to falling objects

When transporting parts/items by hand, there is a danger of loads slipping and falling down.

- ▶ Carry small and medium-size parts/items with two hands.
- ▶ Wear safety shoes with steel toe according to directive EN 347.

⚠ WARNING

Risk of burns in case of contact with hot surfaces

For the operator's safety, the products are designed to avoid thermal risk. However, specific operating conditions may exist that require extra caution on the part of the operator due to the high temperatures (surfaces > 70 °C for parts inside the cover(s)).

- ▶ Wait for the product to fully cool down before working on it.
- ▶ Protective gloves must be worn in accordance with standard EN ISO 21420.

⚠ CAUTION

Risk of crushing related to product tilting

Although the product fully complies with EU safety regulations, there is a risk of tilting when the product is not correctly installed or used.

- ▶ Place the product on a flat, hard floor.
- ▶ Keep the product on its 4 feet.

⚠ CAUTION

Risk of pinching when handling the storage box cover

- ▶ Be careful not to leave your fingers under the cover when closing.

2.1.2 Precautions

i

Duty to provide information on potential dangers

The product holder or user is obliged to make all operating personnel aware of dangers posed by this product.

Every person who is involved in the installation, operation or maintenance of the product must read, understand and adhere to the safety-related parts of this document.

i

Infringement of conformity due to modifications to the product

The Declaration of Conformity from the manufacturer is no longer valid if the operator changes the original product or installs additional equipment.

- Following the installation into a system, the operator is required to check and re-evaluate the conformity of the overall system in the context of the relevant European Directives, before commissioning that system.

Only qualified personnel trained in safety regulations (EMC, electrical safety, chemical pollution) are authorized to carry out the installation and maintenance described in this manual. Our service centers can provide the necessary training.

- ▶ Do not expose any part of the human body to the vacuum.
- ▶ Follow the safety and accident prevention requirements.
- ▶ Regularly check compliance with all precautionary measures.
- ▶ Do not turn on the product if the cover is not in place (unless otherwise stated).

2.2 Intended use

The leak detector is designed to detect and/or quantify a possible installation or component leak by searching for the presence of a tracer gas in the pumped gases.

Only the tracer gases identified in this manual may be used.

The product may be used in an industrial environment.

2.3 Foreseeable misuse

Misuse of the product will render the warranty and any claims void. Any use, whether intended or not, that diverges from the uses already mentioned will be treated as non-compliant; this includes but is not limited to:

- use of a tracer gas with a hydrogen concentration greater than 5%,
- testing parts that are soiled or that have traces of water, vapors, paint, adhesive, detergent or rinsing products,
- pumping of liquids,
- pumping of dust or solids,
- pumping of corrosive, explosive, aggressive or flammable fluids,
- pumping of reactive, chemical or toxic fluids,
- pumping of condensable vapors,
- operation in potentially explosive areas,
- product movement as soon as the product is power on,
- use of accessories or spare parts, which are not named in this manual,
- use of accessories or spare parts, which are not sold by the manufacturer.

The product is not designed to carry people or loads and is not for use as a seat, stepladder or any other similar purpose.

3 Transportation and Storage

3.1 Receipt of the product



Condition of the delivery

- Check that the product has not been damaged during transport.
- If the product is damaged, take the necessary measures with the carrier **and** notify the manufacturer.

- ▶ Keeping the product in its original packaging so it stays as clean as it was when dispatched by us. Only unpack the product once it has arrived at the location where it will be used.



Keep the packaging (recyclable materials) in case the product needs to be transported or stored.

3.2 Unpacking/Packing

Unpacking

Refer to the instructions on the package.

- ▶ Follow the unpacking order indicated on the instructions included in the packaging.

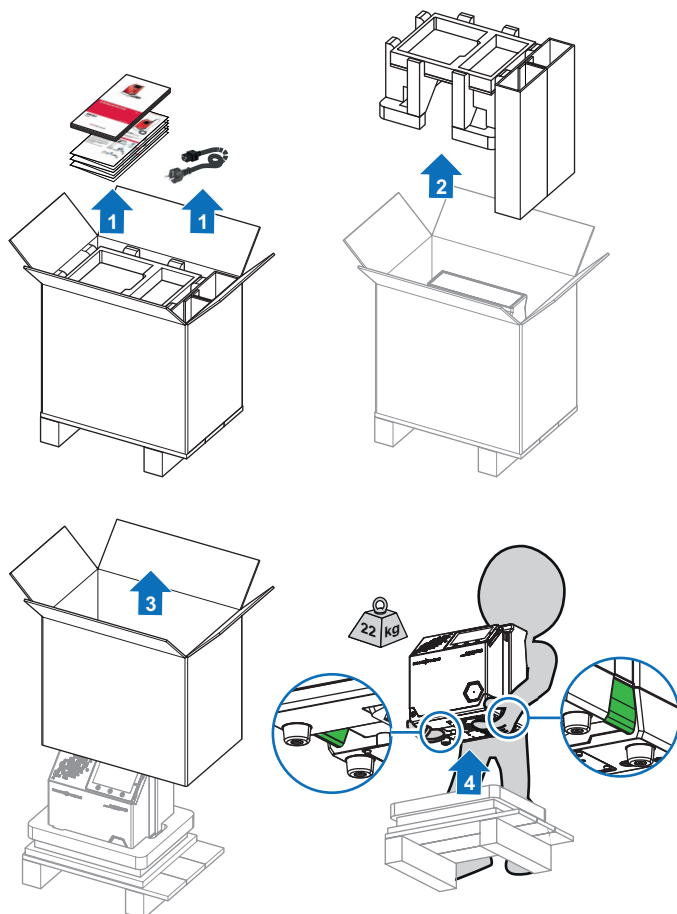

Repacking

1. Remove the calibrated leak, sniffer probe or other accessory installed on the product. Keep it. Do not attach it to the package.
2. Proceed in reverse order of unpacking.

3.3 Handling

⚠ WARNING

Risk of crushing during product handling

Given the weight of the product, there is a risk of crushing during handling operations. Under no circumstances shall the manufacturer be liable if the following instructions are not followed:

- ▶ Only qualified staff trained in handling heavy objects are authorized to handle the product.
- ▶ The lifting devices provided **must be used** for the product and the procedures set out in this document must be followed.

- ▶ Move the product using the gripping areas underneath the product.
- ▶ Do not move the product using the sniffer probe, control panel, power cable or any other communication cable.
- ▶ Turn off the product and unplug it from any power source before moving it.

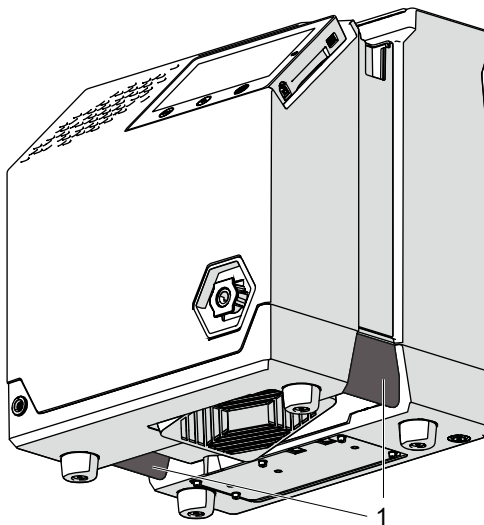

1 Gripping area

Transport cart

A transport cart (accessory) makes it easier to move the detector.

Maximum authorized weight on the transport cart: 26 kg

We recommend using the detector without the cart.

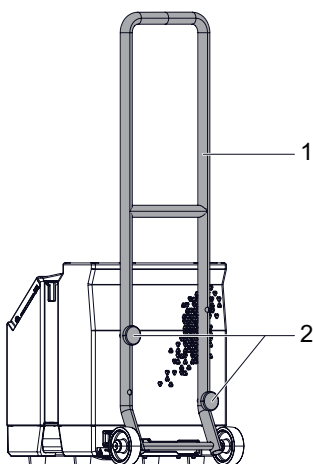

1 Cart 2 Fixing screws delivered with the cart

- ▶ The cart must be fastened to the leak detector using the 2 fixing screws.
- ▶ Do not carry or lift the cart/leak detector assembly by the cart handle.
- ▶ The cart/leak detector assembly should only be moved on a flat surface: do not roll the assembly down stairs.

3.4 Storage



Pfeiffer Vacuum recommends storing the products in their original transport packaging.

Storing a new product

- ▶ Store in a clean and dry environment according to the required temperature conditions (see chapter “Technical data”).
- ▶ Beyond 3 months, factors such as temperature, humidity, salt in the air, etc. could damage some components (elastomers, lubricants, etc.). If this happens, contact a service center.

Extended storage

1. Stop the detector (set switch/circuit breaker to **O**).
2. Wait for the control panel turn off.
3. Unplug the power cable.

4 Product description

4.1 Product identification

To correctly identify the product when communicating with our service center, always have the information from the product rating plate available (see chapter "Labels").

4.1.1 Scope of delivery

- 1 leak detector
- 1 documentation set (USB stick, operating instructions, plastic coated memo for the detector)
- 1 power cable for Europe (France/Germany) and/or 1 power cable for US
- 1 set of 6 partitions for compartmentalization (in the storage box)
- 1 Quality Control label
- 1 sniffer probe sheath and 1 stopper
- 1 D-Sub male connector cover (15 or 37 pins, depending on option)
- 1 D-Sub male connector (15 or 37 pins, depending on option)

To be ordered separately

Reminder: although they are essential for using the leak detector, the following items are accessories (at the user's expense) and are not included with the delivery of the detector:

- sniffer probe with its connection cable,
 - calibrated leak.
- Order these accessories separately from the leak detector.

4.2 Connection interface

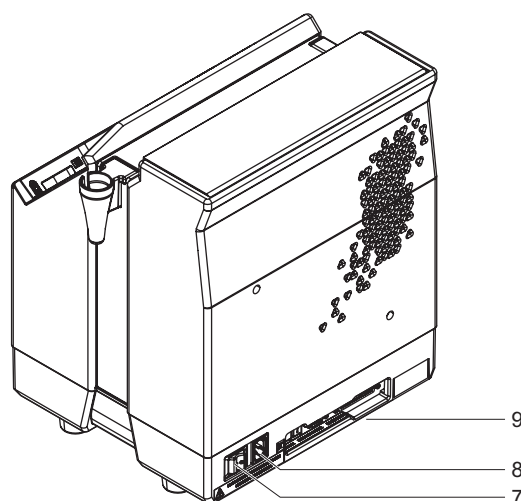
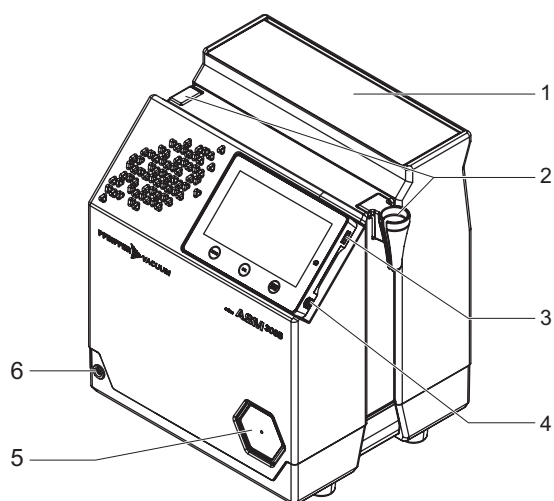

- 1 Storage box with partitions
- 2 Sniffer probe sheath fastening point
- 3 Connector for USB stick (at the user's expense)
- 4 Not used
- 5 Provisional cover for the calibrated storage area ¹⁾

- 6 Sniffer probe connector ¹⁾
- 7 Switch/Circuit breaker
- 8 Mains power supply
- 9 Communication interface according to configuration upon order

1) Accessory

4.3 Control panel description

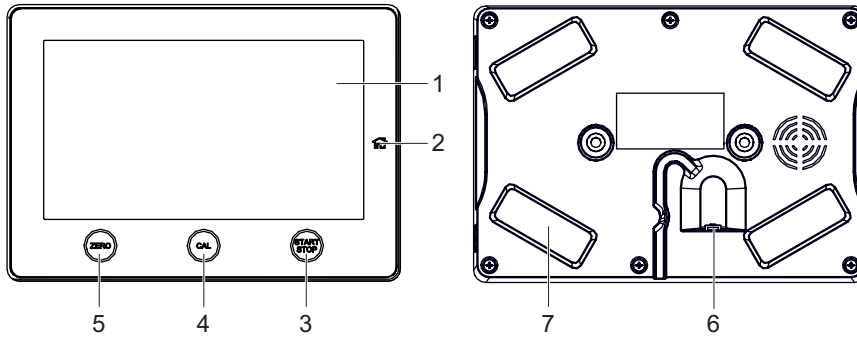

- 1 Touch screen
- 2 Main screen access button
- 3 **START/STOP** button
- 4 **CAL** button
- 5 **ZERO** button
- 6 Detector connection cable connector
- 7 Fixing magnet (x4)

4.4 Description of the sniffer probe

The sniffer probe is an accessory (at the expense of the user).

The sniffer probe does not come with the leak detector.

The sniffer probe is essential for the use of the leak detector.

The leak detector is designed to be used only with the manufacturer’s sniffer probe (part number PRBxxxxxx, see chapter “Accessories”).

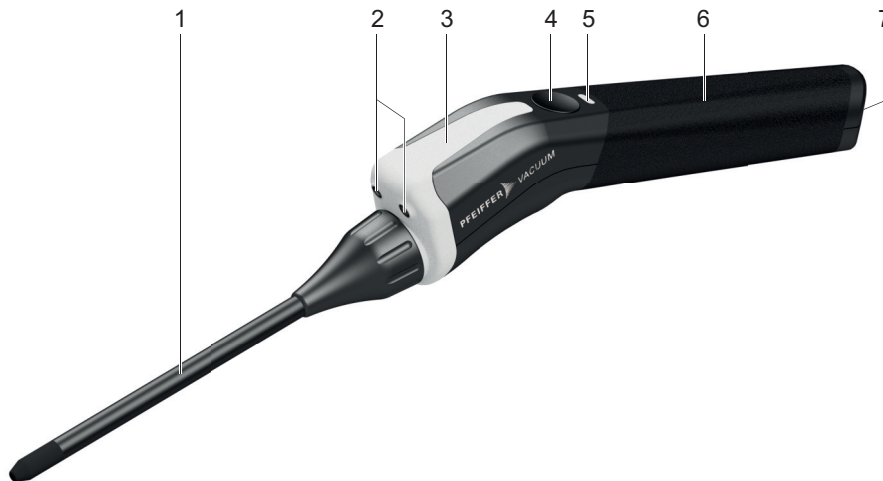



- 1 Rod + filter
- 2 LED light
- 3 LED bargraph (consisting of several LED allowing display customization)
- 4 ZERO button
- 5 LED status
- 6 Probe body
- 7 Sniffer probe cable connector

Coding of the LED display

The representations below indicate the LED status.

Representation	Status
—	OFF
■	ON, fixed e.g. fixed green
■	ON, fixed, alternate e.g. fixed green then fixed orange then fixed red
■	ON, fixed, variable color e.g. fixed green/orange/red according to the setting used as a reference

Representation	Status
	ON, fixed, two colors e.g. fixed green and orange
	ON, flashing e.g. flashing green
	ON, scan LED by LED e.g. 1 st fixed then 2 nd fixed, variable color

Tbl. 1: Coding of the LED display of the sniffer probe

4.5 Description of calibrated leak

The calibrated leak is an accessory (at the expense of the user).

The calibrated leak does not come with the leak detector.

The calibrated leak is essential for the use of the leak detector.

The calibrated leak can contain 3 different tracer gases: ^4He , ^3He or H_2 .

The manufacturer offers 2 calibrated leaks (Value range: $3 \cdot 10^{-5} - 6 \cdot 10^{-5} \text{ mbar} \cdot \text{l/s}$ ($3 \cdot 10^{-6} - 6 \cdot 10^{-6} \text{ Pa} \cdot \text{m}^3/\text{s}$)):

- Tracer gas: 100 % ^4He
- Tracer gas: 100 % H_2

The manufacturer does not offer a calibrated leak with ^3He as the tracer gas.

Each calibrated leak is supplied with a calibration certificate.

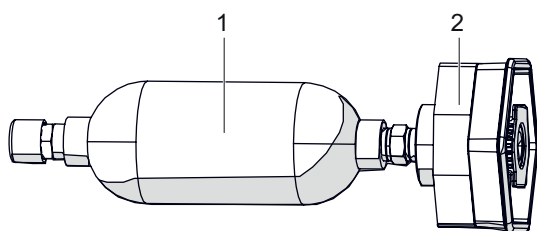

1 Tracer gas tank

2 Calibrated leak nozzle

5 Installation

5.1 Detector installation

NOTICE

Leak detector ventilation

In cases of poor ventilation, there is a risk of deterioration of the detector's internal components by heating.

- ▶ Comply with the ambient operating temperature.
- ▶ Do not obstruct the ventilation grids.
- ▶ Ventilation grids should be cleaned regularly.
- ▶ Leave a free space of at least 10 cm all around the leak detector.
- ▶ Store nothing under the detector.

The leak detector must be installed on a horizontal flat surface resting on its legs.

- ▶ Choose the location for set up according to the dimensions of the detector (see chapter "Dimensions").
- ▶ Handle the detector using the handling device (see chapter "Handling").
- ▶ Make sure that the test area is not polluted by the tracer gas.

5.2 Sniffer probe installation

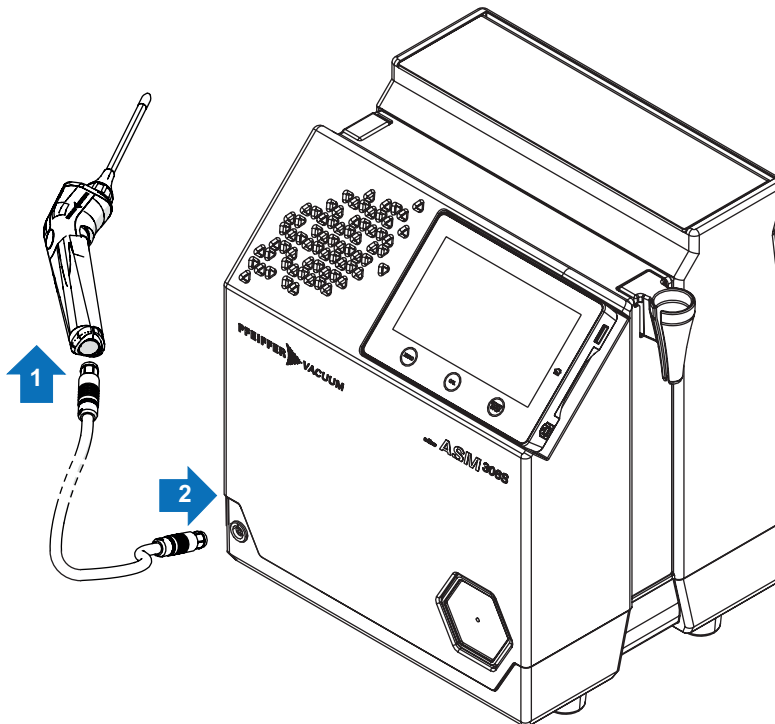

5.3 Calibrated leak installation

The calibrated leak is an accessory (at the expense of the user).

The calibrated leak does not come with the leak detector.

The leak detector includes a dedicated area for keeping the calibrated leak within reach. This storage area comes with a cover.

Placement of the calibrated leak in this area is not required for subsequent use of the leak.

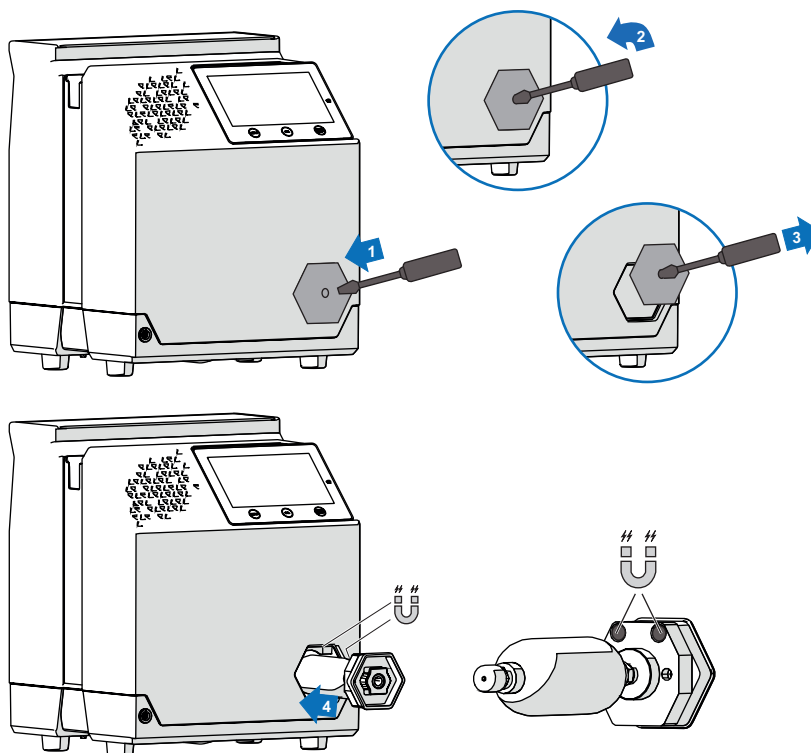

- ▶ Set calibrated leak (see chapter “Calibrated leak setting”).

5.4 Electrical connection

⚠ WARNING

Risk of electric shock due to non-compliant electrical installations

This product uses mains voltage for its electrical supply. Non-compliant electrical installations or installations not done to professional standards may endanger the user's life.

- ▶ Only qualified technicians trained in the relevant electrical safety and EMC regulations are authorized to work on the electrical installation.
- ▶ This product must not be modified or converted arbitrarily.

NOTICE

Risk of electromagnetic disturbance

Voltages and currents can induce a multitude of electromagnetic fields and interference signals. Installations that do not comply with the EMC regulations can interfere with other equipment and the environment in general.

- ▶ Use shielded cables and connections for the interfaces in interference-prone environments.

Electrical safety

The leak detector is Class 1 equipment and therefore must be earthed.

- ▶ Make sure the main switch/circuit breaker is set to **O**.
- ▶ Connect the power supply to the connector using the power cable supplied with the detector (see chapter “Connection interface”).
- ▶ See chapter “Technical characteristics”.

6 Commissioning

6.1 Preliminary precautions for use

Every time it is commissioned:

- ▶ Become familiar with the safety instructions.
- ▶ Check that all the connections are correct.
- ▶ Make sure that the leak detector is in an environment free of tracer gas.

The total weight of the parts, accessories, etc. placed in the storage box must not exceed 5 kg.

6.2 Switching the detector on

1. Connect the mains power cable.
2. Connect the sniffer probe (accessory).
3. Set the switch/circuit breaker to **I**.
4. For first start-up: set the language, unit, date and time (the operator can modify these settings at a later time).
5. Wait for the detector to enter 'Measure' mode.

	Control panel	Sniffer probe ¹⁾
Switching on phase	Display of the different stages of powering on	<ul style="list-style-type: none"> • LED status • LED bargraph
Detector ready for a test	Main screen 'Measure' mode display	<ul style="list-style-type: none"> • LED status • LED bargraph or according to the reject point setting

1) Coding of the LED display: see chapter "Description of the sniffer probe".

Switching on after an extended shutdown

If the detector has been stored or has not been used, switching on time is longer than if it is in regular use.



After a shutdown of the detector for more than 3 months, it is advisable to switch the detector on 24 hours before its use.

6.3 Detector powering off

1. Set the switch/circuit breaker to **O**.
2. Disconnect the mains power cable.
3. Wait 5 minutes before working on the detector, removing the cover or moving the detector.

Pump stop due to power failure

When there is a mains power failure, the detector shuts down: it switches on again automatically when power is restored.

7 Operation

7.1 Prerequisites for optimizing measure

To optimize measuring speed:

- ▶ Test only clean, dry parts/installations with no trace of water, vapor, paint, detergent or rinsing products.
- ▶ Make sure that the test area is not polluted by the tracer gas.
- ▶ No information message should be displayed.
 - No **i Next** pictogram displayed on the main screen.
 - If the pictogram is displayed, read the message and address it.
- ▶ Perform leak detector calibration.
- ▶ Check that the sniffer probe (accessory) is working.
 - The probe flow value displayed on the main screen should not be zero.

7.2 Use conditions

⚠ WARNING

Risk of injury due to the use of hydrogen as tracer gas

Hydrogen can be used as a tracer gas for leak detection. Depending on its concentration, in the worst scenario, there may be a risk of explosion.

- ▶ Never use a tracer gas with a hydrogen content greater than 5%.
- ▶ Use hydrogenated nitrogen as a tracer gas: mix of 95% N₂ and 5% H₂.

NOTICE

Leak detector ventilation

In cases of poor ventilation, there is a risk of deterioration of the detector's internal components by heating.

- ▶ Comply with the ambient operating temperature.
- ▶ Do not obstruct the ventilation grids.
- ▶ Ventilation grids should be cleaned regularly.
- ▶ Leave a free space of at least 10 cm all around the leak detector.
- ▶ Store nothing under the detector.

7.3 Ambient [He] function

The **Ambient [He]** function is used to know the ⁴He tracer gas concentration of ambient air in ppm.

This function is not available for H₂ and ³He tracer gases due to the low concentration of these gases in the ambient air.

This function is not available when the detector is in 'Standby' mode.

To access the function, use the **[[HE] AMBIENT]** function key.

1. Remove the probe from its sheath and place it in the ambient air.
2. Press **[Measure]**.
3. The Helium-4 concentration value is displayed.
 - The normal ⁴He concentration is 5 ppm.
4. To take a new measurement, press **[Measure]** again.

7.4 Tightness test procedure

Sniffer method: the test piece is pressurized with tracer gas. The detector, via a sniffer probe, samples the tracer gas escaping from the piece.

2 test methods are possible: global test or localization test.

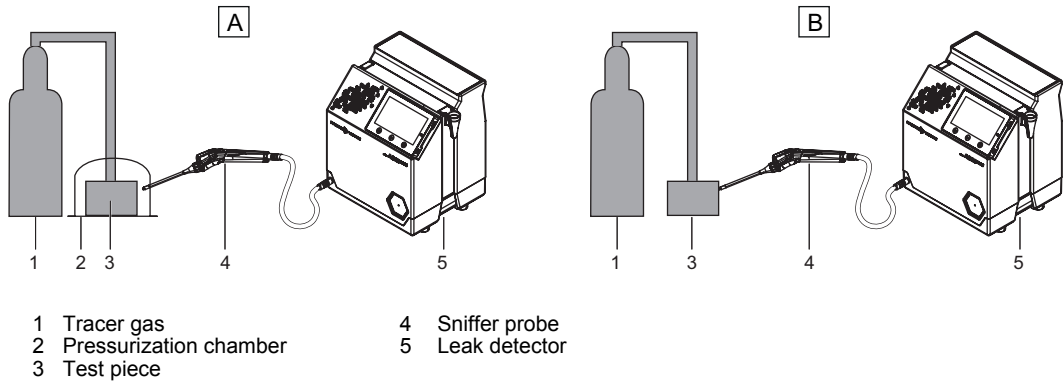

Global test (A)	Localization test (B)
<p>The test piece is placed in a chamber in which there is a sniffer probe.</p> <p>The leak cannot be located.</p> <p>The tracer gas from the leak accumulates over time inside the chamber. The detector measures the total leaks.</p>	<p>The sniffer probe is moved over areas likely to contain leaks. The leak can be located.</p> <p>The detector does not perform a direct measure of the leak.</p> <p>The probe captures only a portion of the tracer gas flow escaping from the test piece according to the positioning of the probe by the user. The captured flow depends on:</p> <ul style="list-style-type: none"> • the distance between the leak and the probe port, • the location of the leak relative to the probe.

7.5 Using the sniffer probe

The leak detector is designed to be used only with the manufacturer’s sniffer probe (see chapter “Accessories”).













- The sniffer probe should be used for the purposes for which it was designed.
- The sniffer probe must not be used in a liquid.
- The sniffer probe must not be inserted into an electrical outlet.
- The sniffer probe must not be introduced into the human body.
- The sniffer probe must not be used without its port.
- The sniffer probe nozzle should not be in contact with temperatures < -20 °C and > 60 °C.

Starting a measure	ECO mode enabled: grip the capacitive handle of the sniffer probe. ECO mode disabled: press the START/STOP button on the control panel.
Stopping a measure	ECO mode enabled: put the sniffer probe down (probe goes into standby mode after 10 minutes). ECO mode disabled: press the START/STOP button on the control panel.
Zero function	Press the ZERO button (see chapter “Zero function”).
Lighting	To light up the test area, the probe is equipped with LED lighting. Touch the metal edge of the LED lights to turn the lights on/off. ¹⁾

1) See chapter “Description of the sniffer probe”

7.6 Operation monitoring

During operation, the user is notified of an incident on the detector control panel and on the sniffer probe.

Type of fault	Control panel	Sniffer probe ¹⁾
Warning	 Press i Next pictograph to display the fault.	'Standby' mode <ul style="list-style-type: none"> LED status  LED bargraph  'Measurement' mode <ul style="list-style-type: none"> LED status  LED bargraph  : color according to the reject set point value
Error	  Message display. Press i Next pictograph to display the fault.	<ul style="list-style-type: none"> LED status  LED bargraph 
Critical error	 Display of a "Critical error - E244" message. Contact a service center.	<ul style="list-style-type: none"> LED status  LED bargraph 

1) LED display coding: see chapter "Description of the sniffer probe" of the operating instructions.

7.7 Test Start/Stop

		From the leak detector	From the sniffer probe
Test start	ECO mode enabled	<ol style="list-style-type: none"> Press the START/STOP button on the control panel. Wait for the detector to enter 'Measure' mode. Then run the sniffer probe slowly over the areas of the part to be tested that may leak: the leak rate displayed varies when a leak is detected (quantitative value of the measured leak rate). 	<ol style="list-style-type: none"> Pick up the sniffer probe. Wait for the detector to enter 'Measure' mode. Then run the sniffer probe slowly over the areas of the part to be tested that may leak: the leak rate displayed varies when a leak is detected (quantitative value of the measured leak rate).
	ECO mode disabled		Test cannot be initiated via the sniffer probe.
Test stop	ECO mode enabled	<ol style="list-style-type: none"> Put the sniffer probe down. Press the START/STOP button on the control panel. 	<ul style="list-style-type: none"> Put the sniffer probe down (do not hold it in your hand). <ul style="list-style-type: none"> The test stops automatically after 10 mn.
	ECO mode disabled	<ul style="list-style-type: none"> Press the START/STOP button on the control panel. 	Test cannot be stopped via the sniffer probe.

7.8 Calibration

Calibration helps ensure that the leak detector is correctly adjusted to detect the tracer gas selected and display the correct leak rate.

7.8.1 External calibration

An external calibrated leak is used to calibrate the leak detector.

It is advisable to use a calibrated leak within the range of 10^{-5} mbar · l/s (10^{-6} Pa · m³/s), containing the set tracer gas (see chapter "Accessories"). However, the choice of the calibrated leak depends on the level of pollution in the work environment.



Detector calibration

20 minutes after switching it on, the detector proposes that the user perform a calibration. For proper use of the detector, **this calibration must be performed.**

It is advisable to perform a calibration:

- at least once a day,
- to optimize the accuracy of the measure,
- if it is uncertain whether the detector is working properly,
- for intense operation: start calibration at the beginning of each work session (e.g. work in shifts, every 8 hours).

1. Check the following settings (access: menu **[Measure]**).
 - The set tracer gas is that of the external calibrated leak used.
 - The name of the calibrated leak reference selected is that of the external calibrated leak used.
 - The information of the external calibrated leak used corresponds to the information provided on the control panel.
 - The type of calibration is 'External'.
2. Place the sniffer probe in the calibrated leak: leak in its dedicated area (1) or held manually (2).

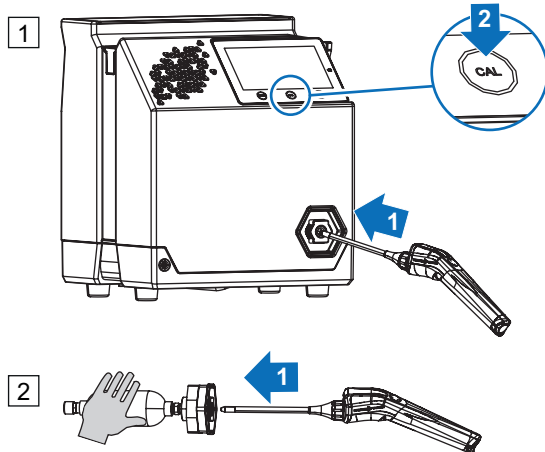

- It is possible to use a calibrated leak other than those proposed by the manufacturer.
 - The manufacturer's calibrated leaks are equipped with a hexagonal nozzle to position the leak in the leak detector cover. This nozzle plays no role in calibration.
3. Press the **CAL** button on the control panel to start calibration.
 - A message is displayed on the control panel if the detector tracer gas and the calibrated leak filling gas are different. Check the 1st step of the procedure.
 4. Following the instructions given by the leak detector. Press **[Next]** to go to the next step.

At the end of the calibration, the detector returns to 'Measure' mode.

7.8.2 Calibration on concentration

A mixture of gases, with known tracer gas concentration, is used to calibrate the leak detector. The helium in ambient air can be used for a calibration on concentration.

Before launching this function, make sure that the leak detector is in an environment free of tracer gas pollution.

1. Check the following settings (access: menu **[Measure]**).
 - The tracer gas concentration of the gas mixture used corresponds the data shown on the control panel.
 - The type of calibration is 'Concentration'.
2. Press the **CAL** button on the control panel to start calibration.
 - A message is displayed on the control panel if the detector tracer gas and the calibrated leak filling gas are different. Check the 1st step of the procedure.
3. Follow the instructions given by the leak detector. Press **[Next]** to move to the next step.

At the end of the calibration, the detector returns to 'Measure' mode.

7.9 Zero function

The zero function is used to identify very small variations in the leak rate in the ambient background. The zero function is permanently enabled: when the detector is turned on, the leak rate displayed is the minimum detectable leak rate.

Perform a zero

Over time, there may be a deviation in the leak rate display. A zero must be performed regularly in the following cases:

- when the background value of the detector increases;
- before performing a precise measure.

There are 2 ways to perform a zero manually:

- ▶ From the control panel, press the **ZERO** button.
- ▶ From the sniffer probe (accessory), press the **ZERO** button.

7.10 Touch screen

The touch screen is interfaced with the detector and is used to:

- display information about the test,
- access the available functions,
- setting of the detector's parameters.



1 Main screen [**Home**]: Information about the current test

2 Graph screen: Monitoring and recording of the leak rate

The content of the screens is provided as an example. Depending on the detector settings, the display may be different.



















- ▶ Remove the film that protects the touch screen upon delivery.
- ▶ Use the touch screen manually without using hard objects such as pens, screwdrivers, etc.
- ▶ Use the RS-232 to control/set the detector if the touch screen is out of service (broken screen).

Screenshot

- ▶ To take a screenshot, press simultaneously on the **ZERO** and [**Home**] buttons on the control panel.
 - The screenshots are always saved in the internal memory.

Name of screenshots: ScreenYYYYMMDD_HHMMSS (Example: Screen20210203_143302).

7.10.1 Navigation

Symbols	
Symbol	Description
	Available on the control panel Return to the main screen from any menu [Home] in the manual
	Return to previous menu
	Access to a sub-menu
 	Access secured with password <ul style="list-style-type: none"> Red closed padlock: unauthorized access (password access) Green open padlock: authorized access
 	Enabling slider <ul style="list-style-type: none"> Black slider: function disabled Green slider: function enabled
	Action button (access to a setting, function, etc.)
	Navigation tools <ul style="list-style-type: none"> << >>: access to the first/last item < >: access to the previous/next item [<< >>] [< >] in the instructions
	Error message
	Critical error message
	Access error/warning message [i Next] in the instructions
	Setting tool <ul style="list-style-type: none"> The green slider indicates the set value. To increase/decrease this value, click on the right/left of the cursor.
	Access to the Settings menus
	Return to home page [X] in the instructions
	Saving the change made [✓] in the instructions
	Display/Hide an area
	Cursor for screen navigation

Access to the main/graphic screen

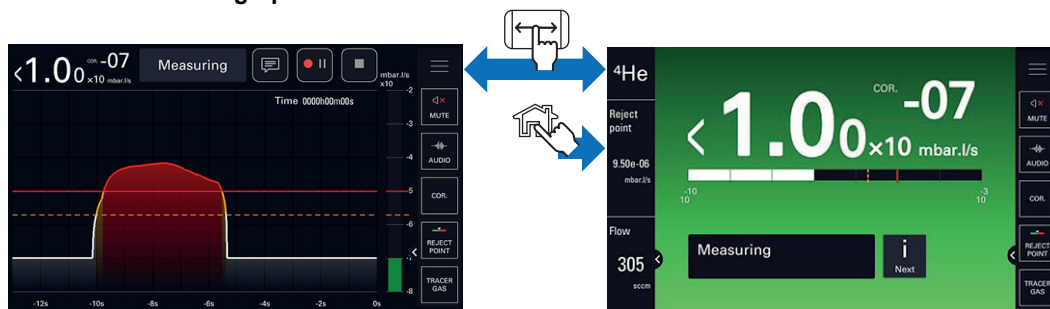

Access to the graph screen, menus and locked function keys

Access to the graph screen, menus and locked function keys may be permitted or prohibited.

- To allow/deny access, see chapter “Access - Password”.

7.10.2 Main screen (Home)

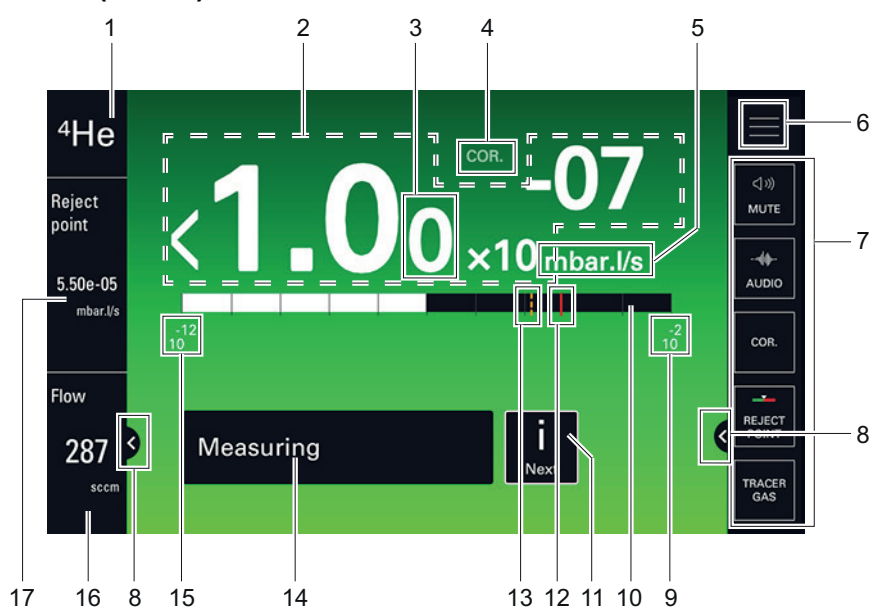

Mark	Function	Name of the pictogram in the operating instructions
1 ¹⁾	Tracer gas	-
2	Digital display of leak rate Gray screen: detector in standby mode, no leak rate displayed (---10---) The color of the screen varies depending on the test result: <ul style="list-style-type: none"> • green screen: measured leak rate below the reject point • red screen: measured leak rate above the reject point 	-
3	Display 2 nd digit	-
4	COR indicator: correction factor applied	-
5	Leak rate unit	-
6	Access to the menu Settings	SETTINGS
7	Function key bar	-
8	Display/Hide an area	EXPAND
9	High decade (max) of the bargraph	-
10	Leak rate bargraph display (color according to test result)	-
11	i Next indicator: error/warning message to be viewed	-
12	Set reject point (red plot)	-

1) Display only

Mark	Function	Name of the pictogram in the operating instructions
13	Set warning point (orange plot)	-
14	Current status of the detector	-
15	Low decade (min) of the bargraph	-
16 ¹⁾	Sniffer probe flow	-
17 ¹⁾	Set reject point bargraph digital display	-

1) Display only

Tbl. 2: Main screen (Home)

7.10.3 Graph screen

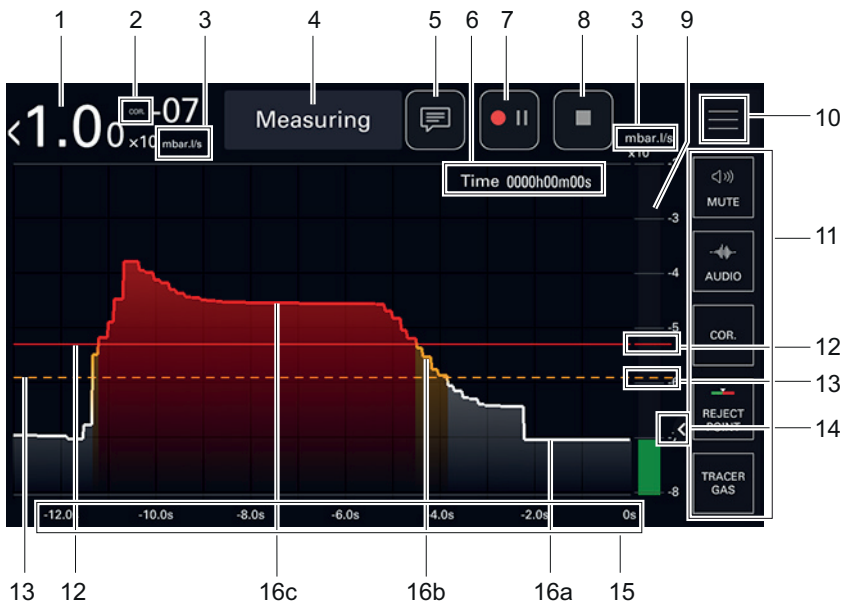

► Click on the screen to access the graph settings (see chapter “Graph screen: graph settings”).

Mark	Function	Name of the pictogram in the operating instructions
1	Digital display of leak rate	-
2	COR indicator: correction factor applied	-
3	Leak rate unit	-
4	Current status of the detector	-
5 ¹⁾	Comments access	COMMENTS
6 ¹⁾	Total recording time	-
7 ¹⁾	Start/Pause recording	START REC
8 ¹⁾	Stop the recording	STOP REC
9	Bargraph display of the leak rate <ul style="list-style-type: none"> • Green bargraph: measured leak rate below the warning point • Orange bargraph: measured leak rate between the warning point and the reject point • Red bargraph: measured leak rate above the reject point 	-
10	Access to the Settings menus	SETTINGS
11	Function key bar	-
12	Set reject point (red plot)	-
13	Set warning point (orange plot)	-

1) Display according to recording settings

Mark	Function	Name of the pictogram in the operating instructions
14	Display/Hide an area	EXPAND
15	Display Time	-
16	Plot of the tracer gas leak rate <ul style="list-style-type: none"> • 16a - white plot: measured leak rate below the warning point • 16b - orange plot: measured leak rate between the warning and the reject point • 16c - red plot: measured leak rate above the reject point 	-

1) Display according to recording settings

Tbl. 3: Graph screen

Navigation

- ▶ During recording, drag the plot to the left/right to browse the recording.

7.10.4 Graph screen: graph parameters

Access: Click on the screen to access the graph parameters.		Choice - Setting limit ¹⁾
High decade	To be set High decade (max) of the bargraph Note: Maximum of 10 decades between high and low decade	-11 – +6
Low decade	To be set Low decade (min) of the bargraph Note: Maximum of 10 decades between high and low decade	-12 – +5
Display Time	To be set Maximum time range displayed on the screen	12 s – 1 h
Auto scale	To be enabled The automatic scale is used to display the measured leak rate centered on 2 or 4 decades. The scale varies according to the leak rate measured. When auto scale is enabled, the scale configured for the leak rate is no longer taken into account. See example below.	Enabled Disabled
Auto scale size	To be selected Number of auto scale decades Example: leak rate = $5 \cdot 10^{-5}$ mbar · l/s ($5 \cdot 10^{-4}$ Pa · m ³ /s) <ul style="list-style-type: none"> • Auto scale 2 decades: scale $1 \cdot 10^{-4}$ – $1 \cdot 10^{-6}$ mbar · l/s ($1 \cdot 10^{-4}$ – $1 \cdot 10^{-7}$ Pa · m³/s) • Auto scale 4 decades: scale $1 \cdot 10^{-3}$ – $1 \cdot 10^{-7}$ mbar · l/s ($1 \cdot 10^{-4}$ – $1 \cdot 10^{-8}$ Pa · m³/s) 	2 decades 4 decades
Sampling time	To be set Time between 2 recorded measures	100 ms – 30 s
Enable record	To be enabled Display/Hide pictograms COMMENTS , START REC and STOP REC of the graph screen (see chapter “Graph Screen”).	Enabled Disabled

1) See chapter “Tree diagram of the Settings menu”

7.10.5 Graph screen: recording

Recording makes it possible to store the measures taken during the test in the control panel memory: **it will not save these measures.**

During a recording, all the detector functions are available.

After the detector is turned off (by a power failure or user manual shutdown), the current recording is cleared.

A record may include several measures. The successive measures are recorded one after the other in the recording: a visual cue (Δ) indicates the measure change.

To start a new recording, you must first save the current one.

When the memory is full and if a recording is in progress, recording is automatically stopped.

1. Update the recording settings if necessary (see chapter "Graph screen: graph parameters").
2. Press the **COMMENTS** pictogram to add a comment (see chapter "Graph screen").
 - Optional: this can be done at any time during the recording or during a pause
 - Comments can be viewed later in the backup .CSV file.
3. Press the **START REC** pictogram to start recording.
 - The pictogram glows red and flashes.
 - None of the measures displayed on the plot before the recording starts will be recorded.
4. If necessary, press the **START REC** pictogram to pause.
 - The pictogram glows red without flashing.
 - None of the measures displayed on the plot during the pause will be recorded.
5. Press the **START REC** pictogram to start recording.
6. Repeat the previous steps as many times as necessary.
7. Press the **STOP REC** pictogram to stop recording.

The message "Stop recording and save" is displayed.

- Return to the recording in progress to continue (the measures already saved will be retained): press **[Cancel]**.
- To stop and save the recording in progress: press **[OK]** (see chapter "Graph screen: saving a recording").

7.10.6 Graph screen: saving a recording

This function is used to save the current record in a .csv file.

Saving is not automatic.

The recording can be saved in a USB stick or in the internal memory of the detector.

To view the saved file (see chapter "Graph screen: viewing a recording").

Saving a file (.csv)

The saved file (.csv) contains all the measures made during the recording. It allows further processing.

The default separator is "tab".

1. Start a recording (see chapter "Graph screen: recording").
2. Press the **STOP REC** pictogram to stop recording (see chapter "Graph screen").
3. The message "Stop recording and save" is displayed: Press **[OK]**.
 - Automatic opening of the File Manager menu window.
4. Select the storage location (**[Internal Memory]** or **[USB Stick]**) of the file to be saved.
5. Click on the lower left frame and enter the name of the file to be saved.
6. Press **[✓]** to confirm the entry.
7. Press **[SAVE]** to complete the recording.
 - The message "Record file saved successfully" is displayed to confirm the recording.

7.10.7 Graph screen: viewing a recording

It is possible to view a recording without stopping a recording in progress, at any time.

Graph history

The function "Graph history" automatically records a history of the leak rate once the leak detector is on.

The recording is in a buffer memory and can be saved.

The maximum duration of the history depends on the current setting:

- 12 s display time: 21 min history
- 1 h display time: 105 h history (≈ 4 days)

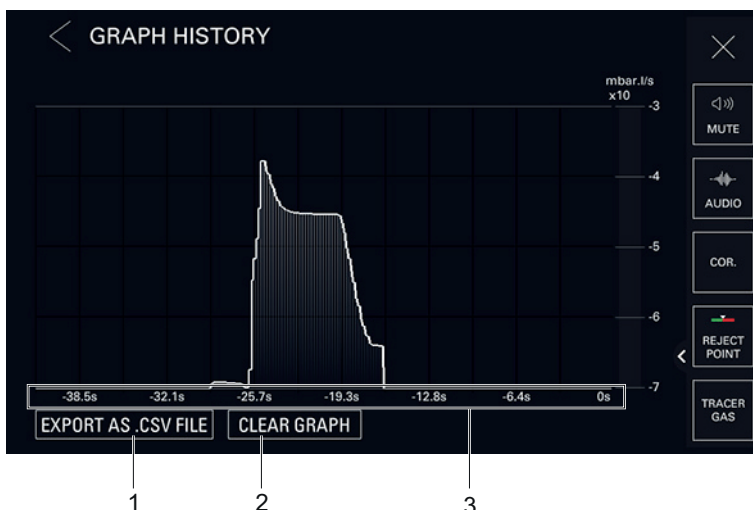

- 1 Button to save a .csv file **[EXPORT AS . CSV FILE]**
- 2 Button to clear the screen **[CLEAR GRAPH]**
- 3 Total recording time



It is possible to view the history or zoom on it, without stopping a recording in progress, by double clicking on the graph screen, at any time.

1. Double click on the graph screen to view "Graph History".
2. Press **[Export as .CSV file]**.
 - Automatic opening of the menu **[File Manager]** window.
3. Select the storage location (**[Internal Memory]** or **[USB Stick]**) of the file to be saved.
4. Click on the lower left frame and enter the name of the file to be saved.
5. Press **[✓]** to confirm the entry.
6. Press **[SAVE]** to complete the recording.
 - The message "Record file saved successfully" is displayed to confirm the recording.

The user can view the details of a measure for each point saved: see "Details of a measure" below.

The user can zoom in on the current display: see "Zoom function" below.

Graph saved

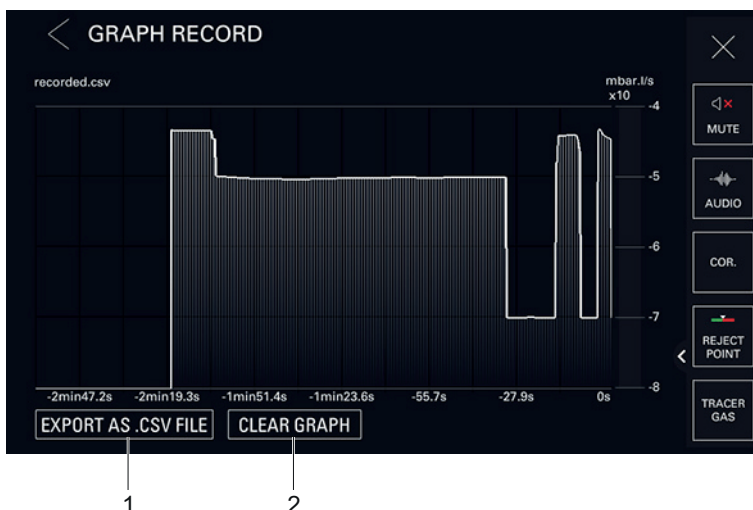

- 1 Button to save a .csv file **[EXPORT AS . CSV FILE]**
- 2 Button to clear the screen **[CLEAR GRAPH]**

1. Access menu **[File Manager]**
2. Select the storage location (**[Internal Memory]** or **[USB Stick]**) of the file to be viewed.
3. Select the file to be viewed (.csv).

4. Press **[OPEN]**.
 - No direct display of the saved measures, but a plot corresponding to the saved measures is displayed.

It is possible to view the details for each measure carried out (see below).
5. After viewing, press **[Delete Graph]** to delete the current display. If this operation is not performed, on opening another file to view, they will accumulate on the screen.
6. To exit the viewing window, press **[X]**.

The user can view the details of a measure for each point saved: see “Details of a measure” below.
 The user can zoom in on the current display: see “Zoom function” below.

Details of a measure

The user can view the details of a measure for each point of the current graph on the graph screen, a recorded graph or the history of the graph.

By viewing a .csv file, the following information can be viewed for each saved point:

- the value of the exact leak rate measured;
- the time of measure with regard to the end of the recording.

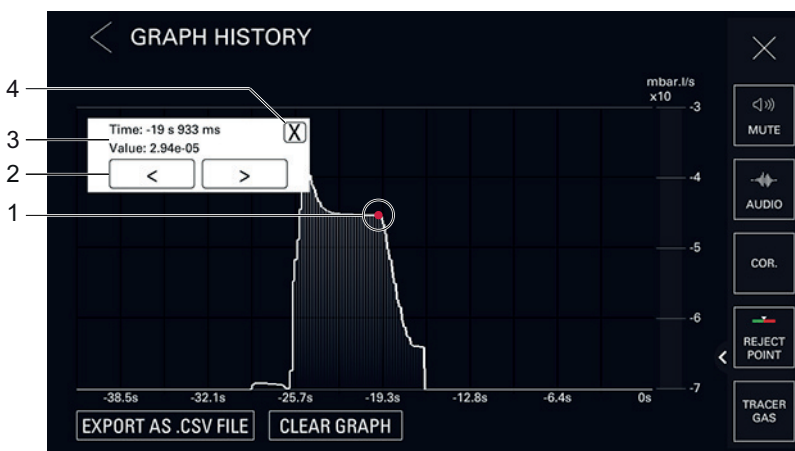

- | | |
|----------------------------------|---|
| 1 Measure selected | 3 Details of the selected measure: <ul style="list-style-type: none"> – Time: time of measure relative to end of recording – Value: exact measured value of the leak rate |
| 2 Point-to-point navigation tool | 4 Window closing |

1. Press the measure point on the graph to be viewed until a red dot appears.
 - A window with details appears.
 - Press on **[X]** to close the window.
2. To adjust the selection, move forward/backward from point to point by pressing the navigation tools.

Zoom function

At any time, it is possible to zoom in on the current display.

- ▶ To zoom in, place two fingers on the touch screen area and move them away from each other.
- ▶ To zoom out, place two fingers slightly apart from each other on the touch screen and bring them towards each other.

7.10.8 Function key bar

The function key bar is used to view settings, access a menu (shortcut) or start a direct action.

It is composed of 2 parts:

- 5 function keys permanently displayed on the right,
 - **[MUTE]**
 - **[AUDIO]**
 - **[TRACER GAS]**

- [REJECT POINT]
- [COR]
- additional function keys not permanently displayed on the left.
 - [INFOR.]
 - [TIMER]
 - [[HE] AMBIENT]
- ▶ To display additional function keys, press the pictogram **EXPAND** (see chapter “Main screen” or “Graph screen”).

Customizing user levels

The contents of the function bar can be customized according to the user level.

Access to function keys may be permitted or prohibited.

- ▶ To allow/deny access, see chapter “Access - Password”.

8 Settings menu

The Settings menu allows the user to set the product according to its specific use.

The functions of the Settings menu are divided into 6 menus.

- ▶ From the control panel, press the **SETTINGS** pictogram (see chapter “Main screen” or “Graph screen”).

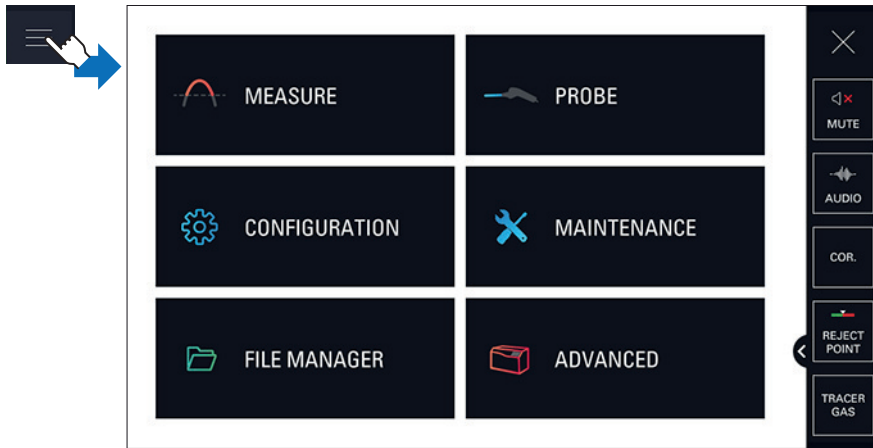

Functions by menu

Menu [MEASURE]

- Tracer gas
- Set points
- Correction factor
- Calibrated leak reference
- Target value
- Calibrated leak settings

Menu [PROBE]

- Probe flow unit
- Probe clogged
- Eco mode

Menu [CONFIGURATION]

- Unit
- Date
- Time
- Language
- Sound volume
- Screen settings
- Access/Password

Menu [MAINTENANCE]

- History
- Information
- Last maintenance operations
- Timers before next maintenance
- Maintenance turbo pump & cell
- Import/Export parameters

Menu [FILE MANAGER]

Menu [ADVANCED]

- Input/Output
- Service

Temporary access to a locked menu

Temporary access: after back to the main screen, the menu is locked again.

- ▶ See chapter “Access - Password”.

Permanent display on the setting menus

The leak rate can be viewed at any time by the user.

The leak rate is permanently displayed on the setting menus (except 'File manger' menu).



1 Digital display of leak rate and its unit

2 COR indicator: correction factor applied

8.1 Measure menu

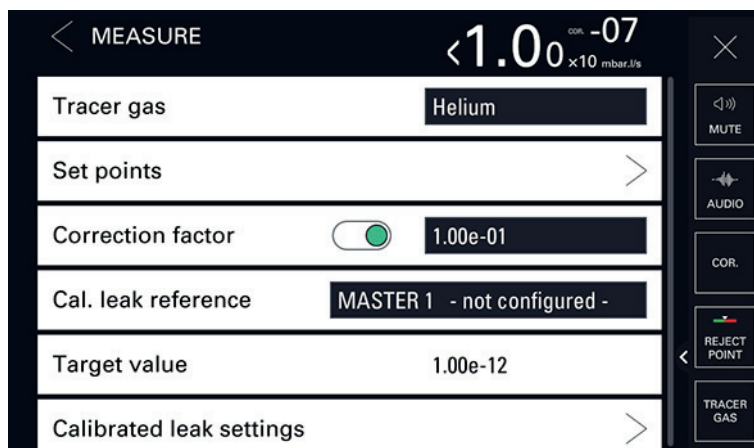

8.1.1 Tracer gas

This menu is used to select the tracer gas.

Access: Menu [Measure] [Tracer Gas]		Choice - Setting limit ¹⁾
Tracer gas	To be selected The tracer gas is the gas searched for during a test.	Helium 4 Helium 3 Hydrogen

1) Default settings: see chapter "Tree diagram of the Settings menu"



For quick access from the main screen, use the [TRACER GAS] function key.

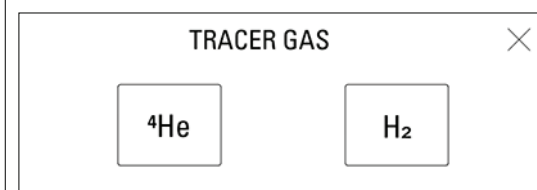

8.1.2 Set points

This menu is used to define the test method used and the set points.

Access: Menu [Measure] [Set Points]		Choice - Setting limit ¹⁾
Sniffing method	<p>To be selected</p> <ul style="list-style-type: none"> • Localization <ul style="list-style-type: none"> – Finding the localization of a leak – Possible taking into account the reject point but not the warning point • Pass-Fail <ul style="list-style-type: none"> – Finding the value of a leak – Taking into account the reject and warning points 	Localization Pass-Fail
Reject point	<p>Only for 'Localization' method</p> <p>To be enabled</p> <p>Display of the test result: see details below.</p> <ul style="list-style-type: none"> • Enabled: reject point taken into account and variable display according to the measured leak. • Disabled: reject point not taken into account and separate display of the measured leak (green screen and white bargraph permanently). 	Enabled Disabled
	<p>To be set for each tracer gas</p> <p>The reject point is the acceptance point for parts.</p> <ul style="list-style-type: none"> • Measured leak rate < reject point: part accepted (Pass) • Measured leak rate > reject point: part rejected (Fail) 	$1 \cdot 10^{-18} - 1 \cdot 10^{+18}$
Warning point	<p>Only for 'Pass-Fail' method</p> <p>To be enabled</p> <p>Setting available only for 'Pass-Fail' method</p> <p>The warning point is an intermediate point defined according to the reject point. It indicates that the user is approaching the reject point, but the tested part is good</p> <p>Display of the test result: see details below.</p>	Enabled Disabled
	<p>To be set</p> <p>Example: reject point = $5 \cdot 10^{-5}$ -> if 20%, warning point = $1 \cdot 10^{-5}$</p>	1 – 99 %
Detector sound	<p>To be selected</p> <p>Type of sound emitted by the detector and/or the probe: see details below.</p> <p>The sound of the detector and/or the probe must be enabled beforehand (see chapter "Sound volume").</p> <p>The sound level can be set (see chapter "Sound volume").</p>	Enabled ²⁾ Disabled Sound 1 ³⁾ Sound 2 ³⁾

1) Default settings: see chapter "Tree diagram of the Settings menu"

2) 'Localization' method only

3) 'Pass-Fail' method only







For quick access from the main screen, use the **[REJECT POINT]** function key.

×
REJECT POINT

Reject point	1.00e-05
Warning point	20 %

Display of the test results

Test result	Display Control panel	Display Sniffer probe ¹⁾
Leak rate below the warning point or the reject point if the alarm threshold is disabled	Screen: green Bargraph: white Graph: white plot	LED bargraph  or  or according to the reject point setting LED Status <input type="text"/>
Leak rate between warning point and reject point	Screen: green Bargraph: orange Graph: orange plot	LED bargraph  LED Status <input type="text"/>
Leak rate greater than the reject point	Screen: red Bargraph: white Graph: red plot	LED bargraph  LED Status <input type="text"/>

1) Coding of the LED display: see chapter "Description of the sniffer probe"

Type of sound

The sound emitted by the detector and the sniffer probe varies according to several parameters.

Parameter	'Localization' method		'Pass-Fail' method					
	Enabled	Disabled	Sound 1	Sound 2	Disa- bled	Sound 1	Sound 2	Disa- bled
Warning Point	-		Off			On		
Detector sound	Enabled	Disabled	Sound 1	Sound 2	Disa- bled	Sound 1	Sound 2	Disa- bled

- **Leak detector: variation of frequency according to measured leak rate**
- **Sniffer probe: variation of the number of beeps per second according to the measured leak rate**

1 - Sound frequency (detector) or number of beeps per second (sniffer probe)

2 - Measured leak rate

3 - Low stop of the bargraph

4 - High stop of the bargraph

5 - Reject point (red plot)

6 - Warning point (orange plot)

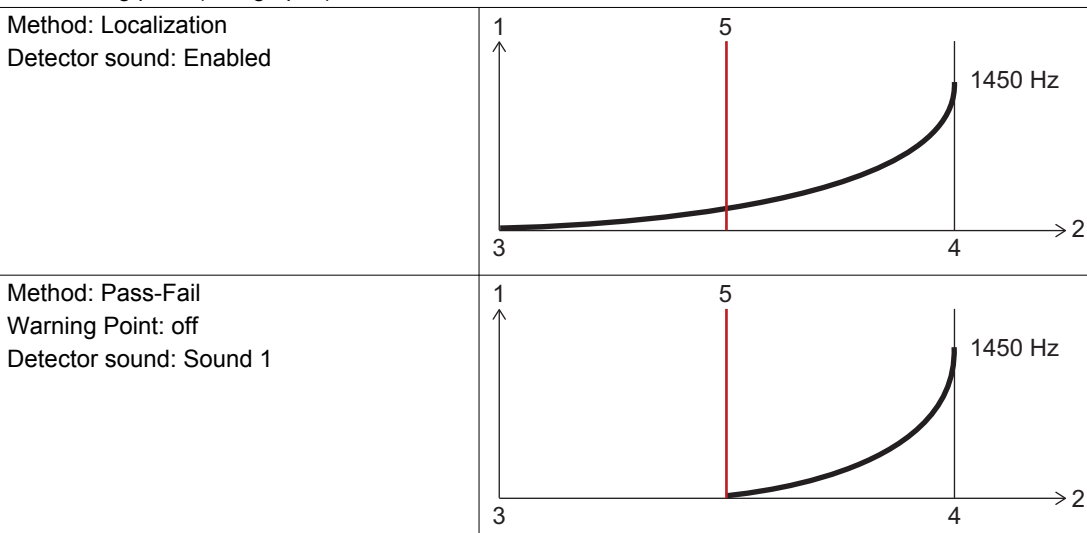

- Leak detector: variation of frequency according to measured leak rate
- Sniffer probe: variation of the number of beeps per second according to the measured leak rate

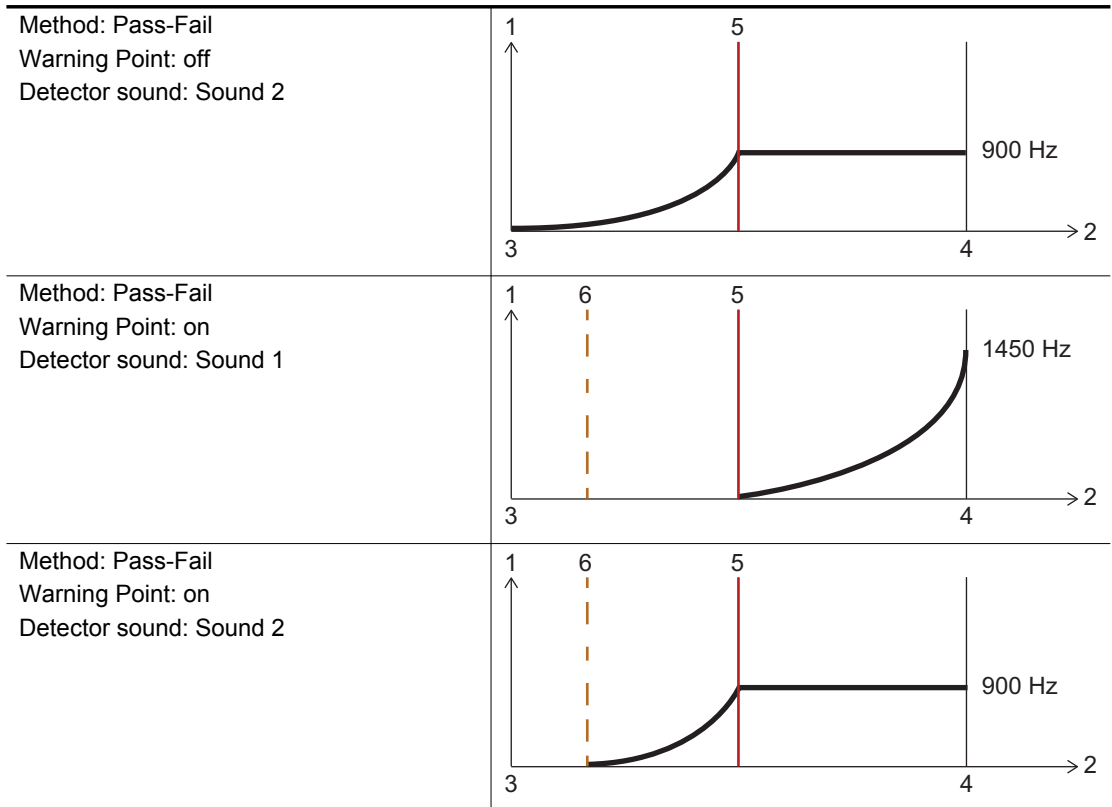

8.1.3 Correction factor

The correction factor is used to correct the leak rate measured by the leak detector when the tracer gas concentration is less than 100%.

A light indicating that the function is enabled is displayed on the main screen.



Use of the correction factor must not replace calibration.

Access: Menu [Measure] [Correction factor]		Choice - Setting limit ¹⁾
Correction factor	To be enabled	Enabled Disabled
	To be set	$1 \cdot 10^{-18} - 1 \cdot 10^{+18}$

1) Default settings: see chapter "Tree diagram of the Settings menu"



For quick access from the main screen, use the [COR] function key.



CORRECTION ✕

Current signal value 1.00e-07 mbar.l/s

Correction factor 1.00e-01

Auto correction >>

Example

The table below shows the leak rate displayed according to the correction factor applied.

E.g. leak rate displayed with calibrated leak of $1 \cdot 10^{-5}$ mbar · l/s ($1 \cdot 10^{-6}$ Pa · m³/s) (with 100% ⁴He)

% He in the gas used	100%	50%	5%	1%
Leak rate displayed on the leak detector without correction factor	$1 \cdot 10^{-5}$ mbar · l/s ($1 \cdot 10^{-6}$ Pa · m ³ /s)	$5 \cdot 10^{-6}$ mbar · l/s ($5 \cdot 10^{-7}$ Pa · m ³ /s)	$5 \cdot 10^{-7}$ mbar · l/s ($5 \cdot 10^{-8}$ Pa · m ³ /s)	$1 \cdot 10^{-7}$ mbar · l/s ($1 \cdot 10^{-8}$ Pa · m ³ /s)
Correction factor value	1	2	20	100
Leak rate displayed on the leak detector with correction	$1 \cdot 10^{-5}$ mbar · l/s ($1 \cdot 10^{-6}$ Pa · m ³ /s)			

Display

The **COR** indicator light is displayed on the control panel when the value of the correction factor is not 1.

The leak rate displayed takes into account the correction factor applied.

Correction factor calculation

1. Press the **START/STOP** button to start a test.
2. Press the **[COR]** function key.
3. Enable the correction factor.
4. If the value of the correction factor to be applied is known:
 - a Set the correction factor to be applied. The correction factor is the coefficient to be applied to the measured leak rate.
 - b Press **[✓]**.
 - c Press **[X]**.
5. If the value of the correction factor is unknown:
 - a Press **[>>]** to access the **[Auto Correction]** function.

<
AUTO CORRECTION
×

Current signal value 1.00e-07 mbar.l/s

Target value **5.00e-06**

- b Press **[Target Value]**.
- c Set the target leak rate of the target value.
- d Press **[Start Calculation]**.
- e Press **[X]** to exit the function.

The value of the correction factor is calculated automatically and updated.

The Correction function is automatically enabled.

8.1.4 Calibrated leak reference

This menu is used to quickly select a recorded calibrated leak reference.

A calibrated leak reference can be:

- an external calibrated leak to perform an external calibration,
- a tracer gas concentration from a mixture of gases to perform calibration on concentration.

Access: Menu [Measure] [Calibrated Leak Reference]		Choice - Setting limit ¹⁾
Calibrated leak reference	To be selected Up to 5 leaks can be recorded by the user.	Not configured

1) Default settings: see chapter "Tree diagram of the Settings menu"

8.1.5 Target value

The target value is the value of the calibrated leak measured and corrected for temperature, taking into account the loss/year.

The temperature and the loss/year must be taken into account on calculating the target value.

This information is provided on the calibrated leak identification label.

Access: Menu [Measure] [Target Value]	
Target value	Read only

8.1.6 Calibrated leak setting

This menu is used to enter and view the settings of the 5 recorded calibrated leak references.

- Update these settings when changing or recalibrating a calibrated leak reference.

The menus shown vary depending on:

- the use of an external calibrated leak with or without a PV code,
- the type of calibration: external or concentration.

Access: Menu [Measure] [Calibrated Leak Settings]		Choice - Setting limit ¹⁾
Cal leak selection	To be selected Establishment of leak name provided by default: <ul style="list-style-type: none"> • Tracer gas • Leak value e.g. ⁴ He 4 · 4e-05 mbar · l/s	Not configured
Name	To be completed (optional)	-
PV cal leak coding	To be enabled To be enabled when using a calibrated leak with a PV code	Enabled Disabled
	To be completed ²⁾ This code is used to automatically create and record a calibrated leak by entering all the leak settings (only the calibrated leaks proposed by the manufacturer) (see chapter "Calibrated leak installation"). Check the accuracy of the data with the rating label of the calibrated leak.	-
Filling gas ³⁾	Read only	-
Value ³⁾	Read only	-
Year of calibration ³⁾	Read only	-
Temperature ³⁾	Read only	0 – 99 °C
Type ⁴⁾	To be completed Type of calibration <ul style="list-style-type: none"> • External: calibration based on external calibrated leak (⁴He, ³He or H₂ leak). • Concentration: calibration from a gas mixture for which the tracer gas concentration is known. 	External Concentration

1) Default settings: see chapter "Tree diagram of the Settings menu"

2) Use the information indicated on the calibrated leak used for calibration or on its calibration certificate.

3) Additional settings if the 'PV cal leak coding' is enabled.

4) Additional settings if the 'PV cal leak coding' is disabled.

Additional settings if the 'Type' is 'External'

Access: Menu [Measure] [Calibrated Leak Settings]		Choice - Setting limit ¹⁾
Filling gas	To be selected ²⁾	Helium 4 Helium 3 Hydrogen
Value	To be set ²⁾	-

1) Default settings: see chapter "Tree diagram of the Settings menu"

2) Use the information indicated on the calibrated leak used for calibration or on its calibration certificate.

Access: Menu [Measure] [Calibrated Leak Settings]		Choice - Setting limit ¹⁾
To be set ²⁾	To be selected ²⁾	mbar · l/s Pa · m ³ /s Torr · l/s atm · cc/s ppm sccm sccs mtorr · l/s gr/yr oz/yr lb/yr
Year of calibration	To be set ²⁾	01/2000 – 12/2099
Loss per year (%)	To be set ²⁾	0,0 – 99,99 °C
Reference temperature (°C)	To be set ²⁾	0 – 99
Temperature coefficient (%/°C)	To be set ²⁾	0,0 – 9,9
Temperature	To be set ²⁾	0 – 99 C

1) Default settings: see chapter “Tree diagram of the Settings menu”

2) Use the information indicated on the calibrated leak used for calibration or on its calibration certificate.

Additional settings if the ‘Type’ is ‘Concentration’

Access: Menu [Measure] [Calibrated Leak Settings]		Choice - Setting limit ¹⁾
Filling gas	To be selected ²⁾	Helium 4 Helium 3 Hydrogen
Value	To be set ²⁾	-
Unit	Read only	ppm

1) Default settings: see chapter “Tree diagram of the Settings menu”

2) Use the information indicated on the calibrated leak used for calibration or on its calibration certificate.

8.2 Probe menu

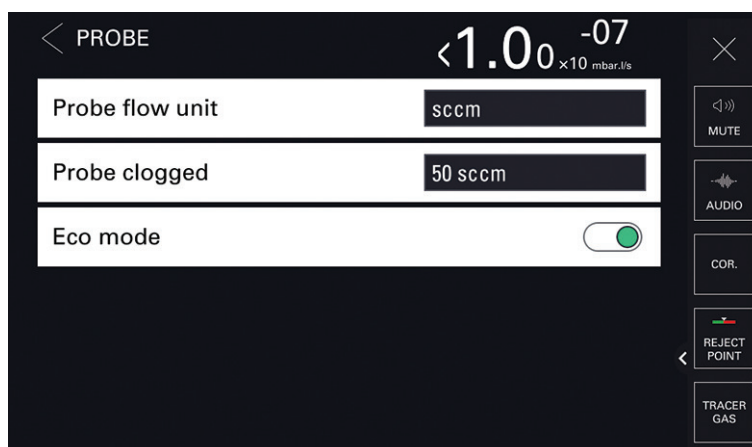

8.2.1 Probe flow unit

This menu is used to set the sniffer probe flow unit.

Access: Menu [Probe] [Probe flow unit]		Choice - Setting limit ¹⁾
Probe flow unit	To be selected The probe flow display shows its level of saturation with respect to a new probe. This makes it possible to determine, for example, when a probe filter change is necessary. <ul style="list-style-type: none"> • %: percentage of measured flow versus flow of a new sniffer probe <ul style="list-style-type: none"> – New probe = 100% • sccm: actual value of the measured flow <ul style="list-style-type: none"> – New probe ≈ 300 sccm ± 10 % (i.e. ≈ 270 – 330 sccm) 	% sccm



1) Default settings: see chapter “Tree diagram of the Settings menu”

8.2.2 Probe clogged

This menu is used to set the probe clogged set point to verify that the sniffer probe (accessory) is operational. When the probe flow is below the **[Probe clogged]** threshold, a code is displayed to inform the operator.

Access: Menu [Probe] [Probe clogged]		Choice - Setting limit ¹⁾
Probe clogged	To be set 100% ≈ 300 sccm ± 10% ((.e. ≈ 270 – 330 sccm)	10 – 90 % 1 – 299 sccm

1) Default settings: see chapter “Tree diagram of the Settings menu”

Fault	Display Control panel	Display Sniffer probe ¹⁾
Probe clogged set point exceeded	Display of i Next pictogram to view the information message. White bargraph	LED bargraph  LED status 

1) Coding of the LED display: see chapter “Description of the sniffer probe”

8.2.3 ECO mode

This menu enables:

- Test launch via “Getting started with the probe”.
- The test is stopped after 10 minutes of probe inactivity.
 - The probe pump inlet cuts out automatically if the test was not stopped using the **START/STOP** button on the control panel.
 - The lifetime of the filters is preserved.

To use the sniffer probe in a test, refer to the chapters “Using the sniffer probe” and “Test start/stop”.



For automated tightness tests, in which the probe is not manipulated by an operator (but by a robot or other system), ECO mode must be disabled.

Access: Menu [Probe] [Eco mode]		Choice - Setting limit ¹⁾
Eco mode	To be enabled	Enabled Disabled

1) Initial setting: see chapter “Tree diagram to the Settings menu”

8.3 Configuration menu

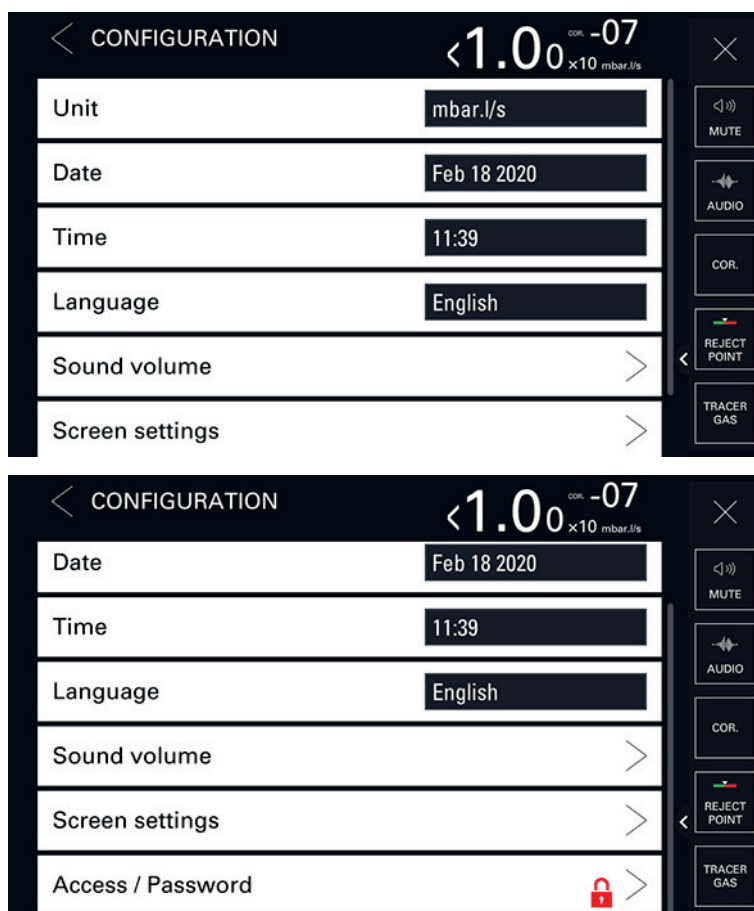

8.3.1 Unit/Date/Time/Language

Access: Menu [Configuration] + as selected [Unit] [Date] [Time] [Language]		Choice - Setting limit ¹⁾
Unit	To be selected ¹⁾	mbar · l/s Pa · m ³ /s Torr · l/s atm · cc/s ppm sccm sccs mtorr · l/s gr/yr oz/yr lb/yr
Date	To be set ¹⁾	- Format: Month Day Year

1) No default settings: set by user on switching the detector on for the 1st time

Settings menu

Access: Menu [Configuration] + as selected [Unit] [Date] [Time] [Language]		Choice - Setting limit ¹⁾
Time	To be set ¹⁾	- Format: hh:mm
Language	To be set ¹⁾	English Spanish German French Japanese Italian Chinese Korean Russian Portuguese

1) No default settings: set by user on switching the detector on for the 1st time

8.3.2 Sound volume

This menu is used to set the sound volumes for the leak detector and the sniffer probe (accessory).

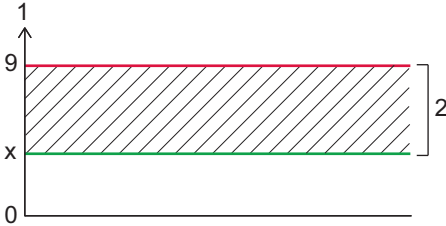
Access: Menu [Configuration] [Sound Volume]		Choice - Setting limit ¹⁾
Detector	To be enabled The audio alarm of the detector informs the user that the reject point has been crossed.	Enabled Disabled
	To be set Level 9 = 90 dBA	0 – 9
Voice	To be enabled The voice of the detector informs the user of the status of the detector or the actions to be carried out.	Enabled Disabled
	To be set	0 – 9
Probe	To be enabled The audio alarm of the sniffer probe informs the user that the reject point has been crossed.	Enabled Disabled
	To be set	0 – 9
Min detector sound	To be enabled The minimum sound level defines a minimum level for the [Detector] and/or [Probe] sounds. 	Enabled Disabled
	To be set The [Detector] and/or [Probe] settings are automatically corrected if the minimum detector sound is greater than the set values. The [Detector] and/or [Probe] settings are maintained if the minimum detector sound is lower than the set values.	0 – 9

1) Default settings: see chapter “Tree diagram of the Settings menu”



For quick access from the main screen, use the **[AUDIO]** function key.

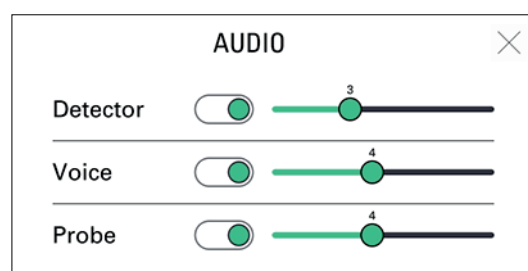

To quickly turn off the sound of the detector and the sniffer probe, use the **[MUTE]** function key.

The red cross on the pictogram indicates that the "Mute" function is enabled.

8.3.3 Screen settings

This menu is used to enter the control panel settings.

Access: Menu [Configuration] [Screen settings]		Choice - Setting limit ¹⁾
Brightness	To be set	0 – 20
Func. Paging	Function available only if a wireless remote control is detected. To be selected When a wireless remote control (accessory) is used, the 'Paging' function makes it possible to easily find the remote if it is located within its field of use with the detector. When the function is activated, the remote control emits a sound signal so it can be located. To stop the sound signal, deselect the Paging function.	No Yes
Leak rate bargraph	See details below	-
Resetting the screen settings	Function launching This function is used to load the default settings of the control panel.	-

1) Default settings: see chapter "Tree diagram of the Settings menu"

Leak rate bargraph details

This menu is used to enter the bargraph settings.

Access: Menu [Configuration] [Leak rate bargraph]		Choice - Setting limit ¹⁾
High decade	To be set High decade (max) of the bargraph	-11– +6
Low decade	To be set Low decade (min) of the bargraph	-12 – +5
Lower display limit	To be set This limit defines the minimum value displayed for the measured leak rate. The measured leak rate is not displayed if it is lower than the set minimum displayed value.	$1 \cdot 10^{-18} - 1 \cdot 10^{+18}$
Display 2 nd digit	To be enabled Display of a second digit after the decimal point for digital display of the leak rate	Enabled Disabled

1) Default settings: see chapter "Tree diagram of the Settings menu"

8.3.4 Access - Password

This menu is used to manage the access rights to the various menus and/or screens.

Regardless of the user level, the password is required to access this menu.

The default password is 5555.



The password is not saved in the control panel. If the password is forgotten, it can be found using the RS-232: see RS-232 operating instructions.

Access: Menu [Configuration] [Access/Password] + password		Choice - Setting limit ¹⁾
User level	To be selected 3 user levels can be used to restrict the display and access to settings and functions. See details below	Restricted access Medium access Full access
Password	To be set This function is used to block access to one or more Settings menus. To access a locked menu, the user will be asked to provide the password.	-
Customized access	To be set Access to certain items may be permitted or prohibited. See details below	-

1) Default settings: see chapter "Tree diagram of the Settings menu"

User level and customized access

The rights defined in the 2 tables below are the **default** rights for each user level.

These rights can be customized: they can be assigned/withdrawn (see chapter "Access - Password").

Default rights for the leak detector	User level		
	Restricted access	Medium access	Full access
START/STOP, CAL, ZERO buttons	Invalid No settings can be made without a password.	Valid	
6 setting menus	Invalid No settings can be made without a password (temporary access allowed)		Valid
Function keys	<ul style="list-style-type: none"> Hidden except [INFO] Displayed if padlock removed (customized access) 		Displayed

Default rights for the sniffer probe (accessory)	User level		
	Restricted access	Medium access	Full access
ZERO button	Invalid	Valid	

Temporary access to a locked menu

To access a locked menu, the user is asked to provide the password.

Temporary access: after back to the main screen, the menu is locked again.

1. Access the Settings menu
2. Press **[Configuration] [Access/Password]**.
3. Enter password.

Access to the graph screen, menus and items locked

Access to the following items may be permitted or prohibited:

- Graph screen
- settings menus: Measure, Probe, Configuration, Maintenance, File Manager and Advanced
- function keys: Audio, Correction, Mute, Reject Point, Infor., Timer and Tracer Gas

1. Access the menu **[Access/Password]**.
2. Press **[Configuration] [Access/Password] + password + [Customized access]**.
3. Press the padlock to lock/unlock.
 - The presence of an open green padlock indicates that access to the item is permitted (unlocked).
 - The presence of a closed red padlock indicates that access to the item is prohibited (locked).

Customizing user levels

Depending on the user level, access to the following items may be permitted or prohibited:

- Graph screen
- settings menus: Measure, Probe, Configuration, Maintenance, File Manager and Advanced
- function keys: Audio, Correction, Mute, Reject Point, Infor., Timer and Tracer Gas

It is possible to customize the rights for each user level.

1. Select the user level to customize.
2. Press **[Configuration] [Access/Password] + password + [Customized access]**.
3. Press the padlock of the item to allow/deny access.
 - a green padlock indicates that access to the item is permitted.
 - If the item is a function key, the function key is added to the function key bar.
 - a red padlock indicates that access to the item is prohibited.
 - If the item is a function key, the function key is removed from the function key bar.
4. Repeat the operation for each user level to be customized.

8.4 Maintenance menu

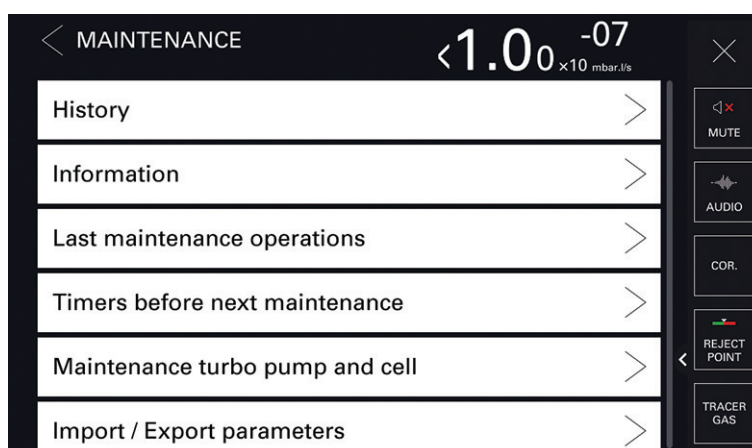

8.4.1 History

This function is used to view the event and calibration histories.

Event history

An event can be an error (Exxx), a warning (Wxxx) or information (lxxx).

The event history records the events that have occurred.

Access: Menu **[Maintenance] [History] [Event History]**

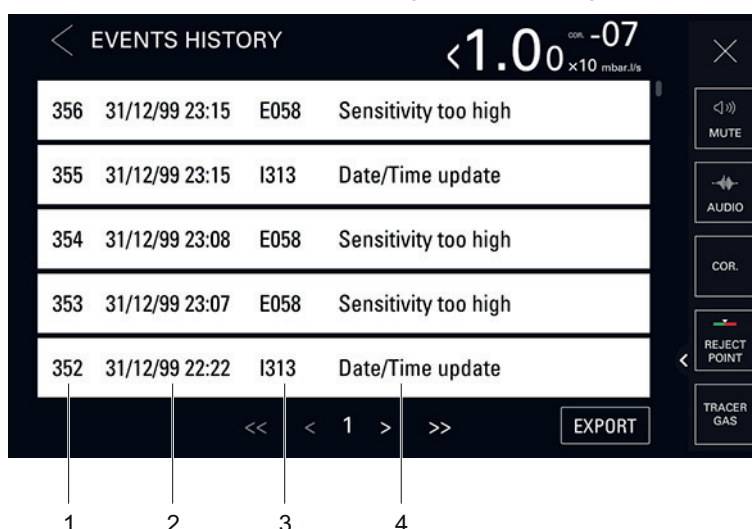

- | | |
|-------------------------------------|----------------------------|
| 1 Chronological number of the event | 3 Code of the event |
| 2 Date and time of the event | 4 Description of the event |

Information codification:

Code	Event	Description
I300	Air inlet	Air inlet
I301	Stop on pollution	Automatic test stop if measured leak rate pollution > Pollution
I302	RVP ctr reset	Backing pump hour timer reset
I303	TMP1 ctr reset	Secondary pump 1 hour timer reset
I306	Fil 1 ctr reset	Filament 1 hour timer reset
I307	Fil 2 ctr reset	Filament 2 hour timer reset
I308	Cycle ctr reset	Cycle counter reset
I309	Ie increase	⁴ He, ³ He: change in emission intensity (Ie) (0.6 – 1.5 mA) H ₂ : change in emission intensity (Ie) (0.3 – 0.6 mA)
I310	Autocal restart	Automatic autocalibration restart
I311	Detector stop	Detector stop
I312	Detector start	Detector start
I313	Date/Time update	Date or time change
I314	CEL firm. update	Analyzer cell firmware update
I315	CPU firm. update	Detector firmware update
I316	LCD Firmware update	Control panel firmware update
I317	Voice update	Voice update
I318	Full param reset	Full detector parameter reset
I319	Fil change	Filament change (manually or automatically from Maintenance menu)
I321	Storage delay	Detector switched off for 15 days (minimum)

Calibration history

The calibration history records the calibrations made.

Access: Menu **[Maintenance] [History] [Calibration History]**

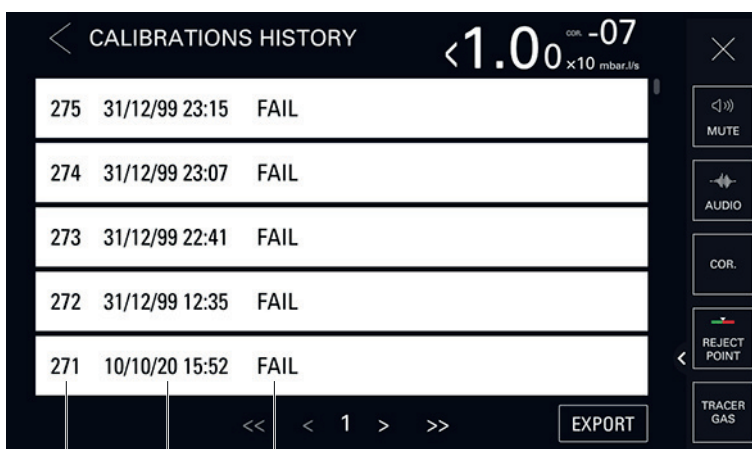

- 1 Chronological number of the calibration
- 2 Date and time of the calibration
- 3 Result of the calibration

History export

An export containing the event and calibration history can be generated.

2 possible modes of access:

- **[Maintenance] [History] [Event History]**
- **[Maintenance] [History] [Calibration History]**

1. Insert a USB stick into the control panel.
2. Press **[Export]**.

The message "Events and calibrations exported" is displayed to confirm the export.

8.4.2 Information

This function is used to view information on the leak detector.



For quick access from the main screen, use the **[INFOR.]** function key.

DETECTOR INFORMATION	
Date & Time	Dec 19 2018 12:06
v.LCD	L0476 V0.2r26 (B40)
v.CPX	L0471 V3.7r84 7BD5
v.CEN	L0264 V3.3r54 FDBEC328
v.PRB	L0474 V1.0r09 FCD1CB6F
Tracer gas	⁴ He
Reject point	4.50e-05
Warning point	25 %
Probe flow	285 sccm
Calibration	Manual
Last calibration	Feb 19 2020 10:28
	Failed
Filament	1 (On)
Status	100 %
Next maintenance	17179 h

Detector information

Reminder: for viewing only in this menu

Access: Menu [Maintenance] [Information] [Detector]

Timer	Number of hours of the detector use
Date and time	Date and time
LCD software release	Control panel firmware information
CPX software release	Leak detector firmware information
CEN software release	Analyzer cell firmware information
PRB software release	Sniffer probe firmware information
Reject point	Reject point set
Warning point	Warning point set
Correction	Correction factor status
Tracer gas	Tracer gas selected
Filament	Filament in use
Cell status	Status of the cell
Last calibration	Time since the last calibration performed
Next maintenance	Time before the next maintenance to be performed
Probe flow	Sniffer probe flow



For quick access from the main screen, use the **[TIMERS]** function key.

TIMERS	
Detector	3645 h
Filament #1	1897 h
Filament #2	21 h
Cycles counter	924
Backing pump	1814 h
Turbo pump	2027 h
Next maintenance	15173 h

Analyzer cell information

Access: Menu [Maintenance] [Information] [Analyzer cell]

Filament in use	Read only Filament used for the measure (2 filaments in the analyzer cell).
Filament	Read only Status of the used filament (Switched on: on - Switched off : off)
Cell status	Read only Performance indicator of the analyzer cell for the used filament. <ul style="list-style-type: none"> • Default settings: between 90% and 100% • Normal operation: between 10% and 100% Normal wear on some cell components will reduce this value over time but will not reduce the accuracy of the detector's measures.
Electronic zero	Read only Use reserved for service centers
Target value	Read only (see chapter "Target value")
Acceleration voltage	Read only Use reserved for service centers
Emission current	Read only Use reserved for service centers
Sensitivity Coefficient	Read only Use reserved for service centers
Cell temperature	Read only Temperature near the analyzer cell
Filament 1	Read only Number of hours of filament operation 1 Function to be launched <ol style="list-style-type: none"> 1. Press number of hours of filament operation 1 2. Press [Reset timer] to reset the timer.
Filament 2	Read only Number of hours of filament operation 2 Function to be launched <ol style="list-style-type: none"> 1. Press number of hours of filament operation 2 2. Press [Reset timer] to reset the timer.

Backing pump maintenance

Access: Menu [Maintenance] [Information] [Backing Pump]

Counter	Press [>] to display the details.
	Read only Number of hours of backing pump operation
	Function to be launched <ol style="list-style-type: none"> 1. Press number of hours of backing pump operation. 2. Press [Reset timer] to reset the timer.
Status	Read only Pump status
Speed	Read only Pump at set operating speed

Turbomolecular pump information

Access: Menu [Maintenance] [Information] [Turbopump]

Counter	Press [>] to display the details.
	Read only Number of hours of turbomolecular pump operation

Access: Menu [Maintenance] [Information] [Turbopump]

Status	Read only Pump status
Speed	Read only Pump at set operating speed

8.4.3 Last maintenance operations

This function displays the last maintenance operations performed on the detector and recorded by the service technician.

The message “No maintenance done” is displayed if no maintenance has been recorded.

Reminder: for viewing only in this menu

Access: Menu [Maintenance] [Last maintenance operations]

Date	Date of the maintenance work
Inspector name	Maintenance technician who performed the work
Number total hours	Number of hours of detector operation at the time of maintenance
Comments	Comment entered by the service technician

8.4.4 Counters before next maintenance

This function displays the remaining periods before the next maintenance.

Reminder: for viewing only in this menu

Access: Menu [Maintenance] [Counters before next maintenance]

Valves	Number of cycles completed versus number of cycles before next maintenance
Backing pump	Number of hours of backing pump operation versus the number of hours before the next maintenance
Turbo pump	Number of hours of turbomolecular pump operation versus the number of hours before the next maintenance

8.4.5 Maintenance turbo pump and cell**Access: Menu [Maintenance] [Maintenance turbo pump & cell]**

		Choice - Setting limit ¹⁾
Filament used	To be selected Filament used for the measure (2 filaments in the analyzer cell).	Filament 1 Filament 2
Stop and vent	Function to be launched This function is used to shut down the secondary pump and for venting so that the secondary pump and the analyzer cell are at atmospheric pressure. See procedure below.	-

1) Default settings: see chapter “Tree diagram of the Settings menu”

Stop and vent

To carry out maintenance on vacuum circuit components, the vacuum circuit of the detector must be at atmospheric pressure.

- Press **[Stop and vent]**.
 - The turbomolecular pump slows to a speed that allows venting.
 - A message notifies the user when the leak detector can be shut down.
 - If the user does not wish to stop the detector, press **[Restart leak detector]**. The detector start-up screen is displayed.
- Stop the leak detector.
- Wait until the control panel turns off completely and unplug the mains power cable before working on the detector.

8.4.6 Import/Export parameters

Export parameters

This function is used to save the detector parameters.

Access: Menu **[Maintenance] [Import/Export parameters]**

The file manager opens (see chapter “File manager menu” of the operating instructions).

1. Press **[Internal Memory]** or **[USB Stick]** to select the desired location.
2. Rename the file, if necessary.
 - The created backup file is called “Setting” by default.
3. Press **[SAVE]**.
 - The backup file is a .CF4. file.

Import parameters

This function is used to load the previously saved detector parameters.

Access: Menu **[File Manager]**.

The file manager opens (see chapter “File manager menu” of the operating instructions).

1. Press **[Internal Memory]** or **[USB Stick]** to select the desired location.
2. Select the backup file to be loaded (.CF4).
3. Press **[OPEN]**.

8.5 File Manager menu

This function is used to manage saved files:

- in the detector’s internal memory,
- on a USB stick.



Type of USB stick

All commercial USB sticks with a FAT 32 format can be used (32 GB max.).

Promotional USB sticks are prohibited: they are not reliable.

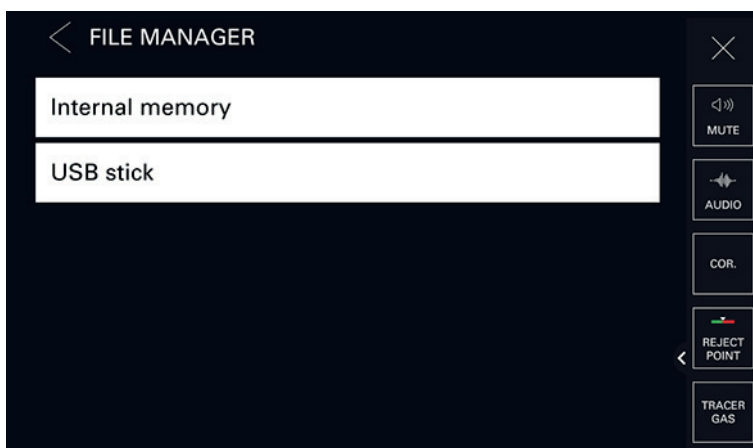

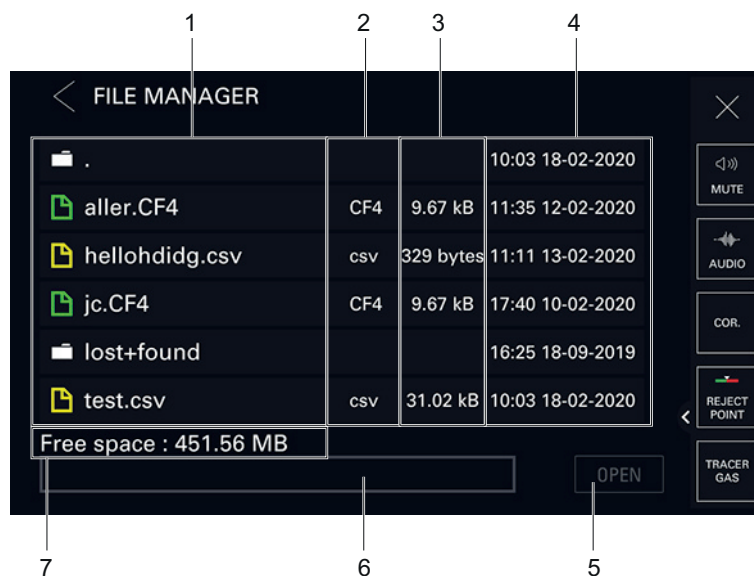

- | | |
|--|---|
| 1 Folder and/or file saved | 4 Navigation tools |
| 2 Date and time saved | 5 Memory size available in the selected medium (USB stick or internal memory) |
| 3 Button for opening the selected file [OPEN] | |

Access to data

1. Insert the USB stick if necessary.
2. Press **[Internal Memory]** or **[USB Stick]** to select the desired medium.

The list of available folders and/or files is displayed.

- a Double click on a folder to access its contents.
- b Select the file to view.
- c Press **[OPEN]** to display it.

Access to 'navigation' and 'edit' modes

1. Press an item (folder or file). It will be highlighted in red.
In 'navigation' mode, any selected item is highlighted in red.
2. Press this item (folder or file) until it is highlighted in green. The 'edit' mode is enabled.

In 'edit' mode, any selected item is highlighted in green.

Possible actions in 'edit' mode:

- Press **[DELETE]** to delete the selected item.
- Press **[RENAME]** to rename the selected item.
- Press **[MOVE TO]** to move the selected item.

3. Press an item (folder or file) until it is highlighted in red. The 'edit' mode is disabled, the 'navigation' mode is enabled.

In 'navigation' mode, any selected item is highlighted in red.

8.6 Advanced menu

Advanced functions reserved for specific uses of the detector (advanced settings requiring proper knowledge of leak detection).

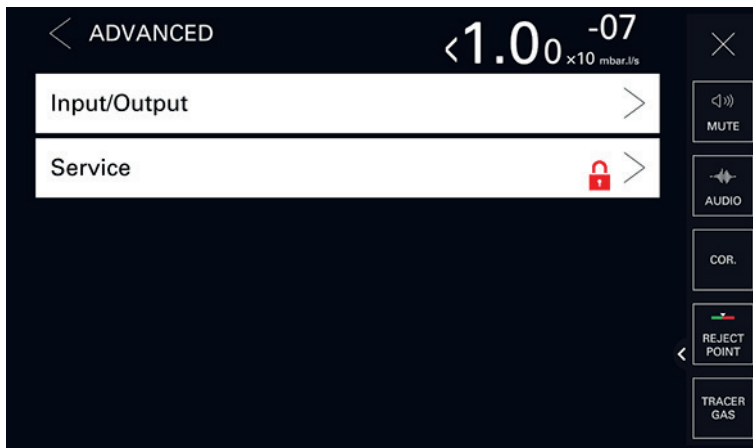

8.6.1 Input/Output

Serial link 1 and serial link 2

The parameters displayed depend on the choices made.

Access: Menu [Advanced] [Input/Output] then [Serial link 1] or [Serial link 2]		Choice - Setting limit
Type	To be selected Type of link according to its use: see the operating instructions of the accessory/ option to be used.	Serial ²⁾ Not used ³⁾ USB ³⁾
Mode	To be selected Link mode according to its use: see the operating instructions of the accessory/ option to be used.	Basic Spreadsheet Advanced Export Data RC 500 WL RC 500 HLT 5xx HLT 2XX Ext. module
Period ⁴⁾	To be set	0 s – 24 h
Handshake	To be selected	Yes No
Module ³⁾	Read only	-
Name ³⁾	Read only	-
Power pin 9 ²⁾	Read only	5 V

1) Default settings: see chapter "Tree diagram of the Settings menu"

2) Serial link 1 only

3) Serial link 2 only

4) 'Spreadsheet' mode only

I/O connector

Access: Menu [Advanced] [Input/Output] [I/O connector]

According to configuration upon order, the detector is equipped with:

- a 15-pin D-Sub I/O interface
- a Profibus and 15-pin D-Sub I/O interface
- a 37-pin D-Sub I/O interface (with USB)
- an Ethernet and 37-pin D-Sub I/O interface (with USB)
- a Profinet and 15-pin D-Sub I/O interface

Refer to the interface operating instructions (see chapter « Applicable documents »)

8.6.2 Service

Access to the Service menu is password protected.
Reserved for the Service Centers.

9 Maintenance/Replacement

Maintenance intervals and responsibilities

The detector maintenance operations are described in the Maintenance instructions for the detector.

The manual specifies:

- maintenance intervals,
- maintenance instructions,
- shutting the product down,
- tools and spare parts.

10 Service solutions by Pfeiffer Vacuum

We offer first-class service

High vacuum component service life, in combination with low downtime, are clear expectations that you place on us. We meet your needs with efficient products and outstanding service.

We are always focused on perfecting our core competence – servicing of vacuum components. Once you have purchased a product from Pfeiffer Vacuum, our service is far from over. This is often exactly where service begins. Obviously, in proven Pfeiffer Vacuum quality.

Our professional sales and service employees are available to provide you with reliable assistance, worldwide. Pfeiffer Vacuum offers an entire range of services, from [original replacement parts](#) to [service contracts](#).

Make use of Pfeiffer Vacuum service

Whether preventive, on-site service carried out by our field service, fast replacement with mint condition replacement products, or repair carried out in a [Service Center](#) near you – you have various options for maintaining your equipment availability. You can find more detailed information and addresses on our homepage, in the [Pfeiffer Vacuum Service](#) section.

You can obtain advice on the optimal solution for you, from your [Pfeiffer Vacuum representative](#).

For fast and smooth service process handling, we recommend the following:



1. Download the up-to-date form templates.
 - [Explanations of service requests](#)
 - [Service requests](#)
 - [Contamination declaration](#)



- a) Remove and store all accessories (all external parts, such as valves, protective screens, etc.).
 - b) If necessary, drain operating fluid/lubricant.
 - c) If necessary, drain coolant.
2. Complete the service request and contamination declaration.



3. Send the forms by email, fax, or post to your local [Service Center](#).

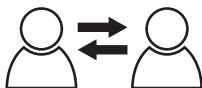

4. You will receive an acknowledgment from Pfeiffer Vacuum.

PFEIFFER VACUUM

Submission of contaminated products

No microbiological, explosive, or radiologically contaminated products will be accepted. Where products are contaminated, or the contamination declaration is missing, Pfeiffer Vacuum will contact you before starting service work. Depending on the product and degree of pollution, **additional decontamination costs** may be incurred.

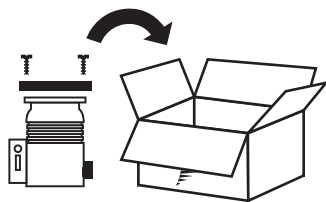

5. Prepare the product for transport in accordance with the provisions in the contamination declaration.
 - a) Neutralize the product with nitrogen or dry air.
 - b) Seal all openings with blind flanges, so that they are airtight.
 - c) Shrink-wrap the product in suitable protective foil.
 - d) Package the product in suitable, stable transport containers only.
 - e) Maintain applicable transport conditions.

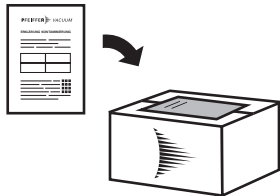

6. Attach the contamination declaration to the **outside** of the packaging.

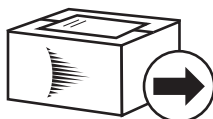

7. Now send your product to your local Service Center.

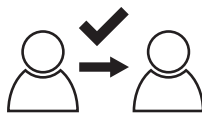

8. You will receive an acknowledgment/quotation, from Pfeiffer Vacuum.

PFEIFFER VACUUM

Our sales and delivery conditions and repair and maintenance conditions for vacuum devices and components apply to all service orders.

11 Accessories

Accessory		Description	Part Number
Sniffer probe	Rigid and short	With connection cable of 2 m	PRB2H02HA
		With connection cable of 5 m	PRB2H05HA
		With connection cable of 10 m	PRB2H10HA
	Flexible and long	With connection cable of 2 m	PRB2H02HD
		With connection cable of 5 m	PRB2H05HD
		With connection cable of 10 m	PRB2H02HD
Calibrated leak (Value range: $3 \cdot 10^{-5} - 6 \cdot 10^{-5}$ mbar · l/s ($3 \cdot 10^{-6} - 6 \cdot 10^{-6}$ Pa · m ³ /s))		100 % ⁴ He	127388
		100 % H ₂	127387
Communication interface		Inputs/Outputs 37 pins	127258S
		Inputs/Outputs 37 pins with Ethernet	127256S
		Profinet with Inputs/Outputs 15 pins	127255S
		Profibus with Inputs/Outputs 15 pins	127257S
Transport cart		-	114820
Maintenance set		-	114718

Tbl. 4: Accessories

12 Technical data and dimensions

12.1 General

Databases of technical characteristics of Pfeiffer Vacuum leak detectors:

- Technical characteristics according to:
 - AVS 2.3: Procedure for calibrating gas analyzers of the mass spectrometer type
 - EN 1518: Non-destructive testing. Leak testing. Characterization of mass spectrometer leak detectors
 - ISO 3530: Methods of calibrating leak-detectors of the mass-spectrometer-type used in the field of vacuum technology
- Standard conditions: 20 °C, 5 ppm ⁴He ambient conditions, degassed detector

12.2 Technical data

Characteristics	ASM 306S
Detectable gas	⁴ He, ³ He, H ₂
Minimum detectable leak rate for ⁴ He	1 · 10 ⁻⁷ mbar · l/s 1 · 10 ⁻⁸ Pa · m ³ /s
Minimum detectable leak rate for H ₂	5 · 10 ⁻⁷ mbar · l/s ¹⁾ 5 · 10 ⁻⁸ Pa · m ³ /s ¹⁾
Start-up time (20 °C) without calibration	2 min
Response time	< 1 s
Test method	Sniffing
Sound level	55 dB (A)
Operating temperature	10 – 40 °C
Power supply ²⁾	100 – 240 V
Frequency	50/60 Hz
Maximum consumption (230 V)	300 W
Weight	22 kg
Dimension (L x l x H)	350 x 305 x 421 mm

1) The best sensitivity is achieved after degassing.

2) According to IEC/UL/CSA regulations, products can withstand a supply voltage variation of ± 10%.

Tbl. 5: Technical data

Environmental conditions	ASM 306S
Use temperature	15 – 40 °C
Storage temperature	-25 – +70 °C
Maximum air humidity	80% at 31°C, linear decrease to 50% at 40°C
Maximum magnetic field	3 mT
Use	Interior
Maximum altitude above sea level	2000 m
Pollution degree	II
Penetration protection rating	IP 20

Tbl. 6: Environmental conditions

12.3 Units of pressure

Unit	mbar	bar	Pa	hPa	kPa	Torr / mm Hg
mbar	1	$1 \cdot 10^{-3}$	100	1	0.1	0.75
bar	1000	1	$1 \cdot 10^5$	1000	100	750
Pa	0.01	$1 \cdot 10^{-5}$	1	0.01	$1 \cdot 10^{-3}$	$7.5 \cdot 10^{-3}$
hPa	1	$1 \cdot 10^{-3}$	100	1	0.1	0.75
kPa	10	0.01	1000	10	1	7.5
Torr / mm Hg	1.33	$1.33 \cdot 10^{-3}$	133.32	1.33	0.133	1

1 Pa = 1 N/m²

Tbl. 7: Units of pressure and their conversion

12.4 Gas throughputs

Unit	mbar l/s	Pa m ³ /s	sccm	Torr l/s	atm cm ³ /s
mbar l/s	1	0.1	59.2	0.75	0.987
Pa m ³ /s	10	1	592	7.5	9.87
sccm	$1.69 \cdot 10^{-2}$	$1.69 \cdot 10^{-3}$	1	$1.27 \cdot 10^{-2}$	$1.67 \cdot 10^{-2}$
Torr l/s	1.33	0.133	78.9	1	1.32
atm cm ³ /s	1.01	0.101	59.8	0.76	1

Tbl. 8: Gas throughputs and their conversion

12.5 Dimensions

(mm)

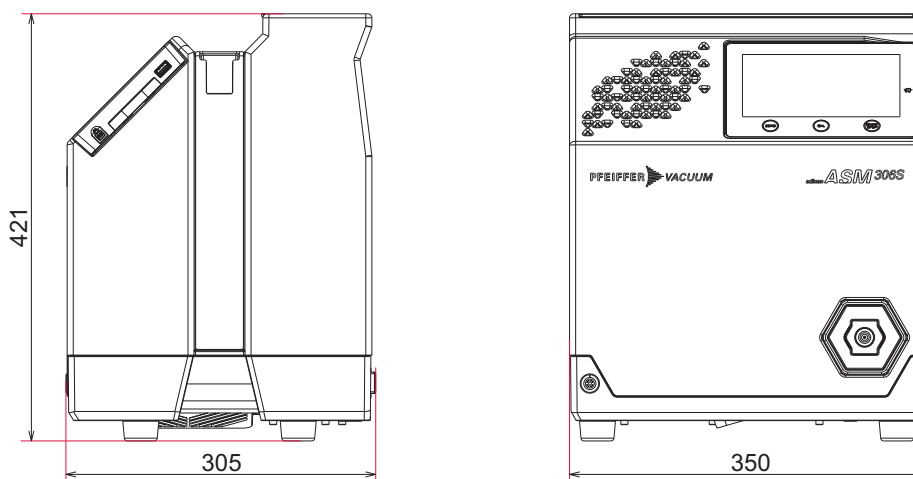

13 Appendix

13.1 Tree diagram of the Settings menu

Next tables indicate the default settings for the leak detector.

When the leak detector is switched off, values and parameters are saved for the next start-up.

Menu [MEASURE]		Choice - Setting limit	
Tracer gas		Helium 4 ¹⁾ Helium 3 Hydrogen	
Set points	Sniffing method	Localization Pass-Fail ¹⁾	
	Reject point	Status	Enabled ¹⁾ Disabled
		Setting	$1 \cdot 10^{-18} - 1 \cdot 10^{+18}$ $5 \cdot 10^{-5}$ ¹⁾
	Warning point	Status	Enabled ¹⁾ Disabled
		Setting	1 – 99 % 20 % ¹⁾
	Detector sound		Enabled Disabled Sound 1 ¹⁾ Sound 2
Correction factor	Status	Enabled Disabled ¹⁾	
	Setting	$1 \cdot 10^{-18} - 1 \cdot 10^{+18}$ $1 \cdot 10^0$ ¹⁾	
Calibrated leak reference		Not configured	
Target value		- ²⁾	

1) Default setting

2) General information: Read only

4) Information indicated on the calibrated leak used for calibration or on its calibration certificate.

Tbl. 9: Default settings: menu [MEASURE] (1/2)

Menu [MEASURE]		Choice - Setting limit
Calibrated Leak Settings	Cal leak selection	Not configured
	Name	-
	PV cal leak coding	Enabled ¹⁾ Disabled
	<i>Additional settings if the 'PV cal leak coding' is enabled:</i>	
	Filling gas	- ²⁾
	Value	- ²⁾
	Year of calibration	- ²⁾
	Temperature	0 – 99 23 ¹⁾
	<i>Additional settings if the 'PV cal leak coding' is disabled:</i>	
	Type	External ¹⁾ Concentration
	<i>Additional settings if the 'Type' is 'External'</i>	
	Filling gas ⁴⁾	Helium 4 ¹⁾ Helium 3 Hydrogen
	Value ⁴⁾	- ⁴⁾
	Unit ⁴⁾	mbar · l/s ¹⁾ Pa · m ³ /s Torr · l/s atm · cc/s ppm sccm sccs mtorr · l/s gr/yr oz/yr lb/yr
	Year of calibration ⁴⁾	01/2000 – 12/2099 01/2099 ¹⁾
	Loss per year (%) ⁴⁾	0,0 – 99,99 2 ¹⁾
	Reference temperature (°C) ⁴⁾	0 – 99 23 ¹⁾
	Temperature coefficient (%/°C) ⁴⁾	0,0 – 9,9 0,2 ¹⁾
	Temperature ⁴⁾	0 – 99 23 °C ¹⁾
	<i>Additional settings if the 'Type' is 'Concentration'</i>	
	Filling gas ⁴⁾	Helium 4 ¹⁾ Helium 3 Hydrogen
	Value ⁴⁾	- ⁴⁾
	Unit	ppm ²⁾

1) Default setting

2) General information: Read only

4) Information indicated on the calibrated leak used for calibration or on its calibration certificate.

Tbl. 10: Default settings: menu [MEASURE] (2/2)

Menu [PROBE]	Choice - Setting limit
Probe flow unit	% sccm ¹⁾
Probe clogged	10 – 90 % 15 % ¹⁾ 1 – 299 sccm 45 sccm ¹⁾
Eco mode	Enabled ¹⁾ Disabled

1) Default setting

Tbl. 11: Default settings: menu [PROBE]

Menu [CONFIGURATION]	Choice - Setting limit
Unit	- ³⁾ mbar · l/s Pa · m ³ /s Torr · l/s atm · cc/s ppm sccm sccs mtorr · l/s gr/yr oz/yr lb/yr
Date	- ³⁾ Format: Month Day Year
Time	- ³⁾ Format: hh:mm
Language	- ³⁾ English Spanish German French Japanese Italian Chinese Korean Russian Portuguese

1) Default setting

3) No default setting: setting performed by the user at the 1st detector start.

Menu [CONFIGURATION]			Choice - Setting limit
Sound volume	Detector	Status	Enabled ¹⁾ Disabled
		Setting	0 – 9 4 ¹⁾
	Voice	Status	Enabled ¹⁾ Disabled
		Setting	0 – 9 3 ¹⁾
	Probe	Status	Enabled Disabled ¹⁾
		Setting	0 – 9 4 ¹⁾
	Min detector sound	Status	Enabled Disabled ¹⁾
		Setting	0 – 9 0 ¹⁾

1) Default setting

3) No default setting: setting performed by the user at the 1st detector start.

Tbl. 12: Default settings: menu [CONFIGURATION] (1/2)

Menu [CONFIGURATION]			Choice - Setting limit
Screen settings	Brightness	Setting	0 – 20 15 ¹⁾
	Func. Paging	Without remote control detected	-
		With remote control detected	No ¹⁾ Yes
	Leak rate bargraph	High decade	-11– +6 -3
		Low decade	-12 – +5 -7 ¹⁾
		Lower display limit	$1 \cdot 10^{-18} - 1 \cdot 10^{+18}$ $1 \cdot 10^{-7}$ ¹⁾
		Display 2 nd digit	Enabled Disabled ¹⁾
Resetting the screen settings	Function launching	-	
Access/Password	User level		Restricted access Medium access Full access ¹⁾
	Password		5555 ¹⁾
	Customized access	Function access	-

1) Default setting

3) No default setting: setting performed by the user at the 1st detector start.

Tbl. 13: Default settings: menu [CONFIGURATION] (2/2)

Menu [MAINTENANCE]		Choice - Setting limit	
History	Event History	-	
	Calibration History	-	
Information	Detector	General information access	- 2)
		Analyzer cell	General information access
	Backing Pump	Reset timer	-
		Function launching	-
	Turbopump	General information access	- 2)
		Reset timer	-
	Last maintenance operations	General information access	- 2)
		Counters before next maintenance	General information access
Maintenance turbo pump & cell	Filament used	Filament 1 ¹⁾ Filament 2	
	Stop and vent	Function launching	-
Import/Export parameters	Function launching	-	

1) Default setting

2) General information: Read only

Tbl. 14: Default settings:menu [MAINTENANCE]

Menu [FILE MANAGER]	Choice - Setting limit
Internal Memory	-
USB Stick	-

Tbl. 15: Default settings: menu [FILE MANAGER]

Menu [ADVANCED]		Choice - Setting limit	
Input/Output	Serial link 1	Type	Serial ¹⁾
		Mode	Basic Spreadsheet Advanced ¹⁾ Export data RC 500 WL RC 500 HLT 5xx HLT 2xx Ext. module
		Period (if 'Spreadsheet' mode)	0 s – 24 h 1 s ¹⁾
		Handshake	Oui Non ¹⁾
		Power pin 9	-5 V ¹⁾
	Serial link 2	Type	Not used USB ¹⁾
		Mode	Basic Spreadsheet Advanced ¹⁾ Export data RC 500 WL RC 500 HLT 5xx HLT 2xx Ext. module
		Period (if 'Spreadsheet' mode)	0 s – 24 h 1 s ¹⁾
		Handshake	Yes No ¹⁾
		Module (if 'Anybus' type)	- ¹⁾
		Name (if 'Anybus' type)	- ¹⁾
	I/O Connector	Quick view ⁶⁾	- ⁵⁾
		Analog Output	- ⁵⁾
Digital input ⁶⁾		- ⁵⁾	
Digital transistor output ⁶⁾		- ⁵⁾	
Digital relay output ⁶⁾		- ⁵⁾	
Configuration par défaut ⁶⁾		- ⁵⁾	
Other configurations ⁶⁾		- ⁵⁾	
Service	Access to the Service menu is password protected. Reserved for the Service Centers.	-	

1) Default setting

5) See the I/O interface operating instructions

6) 37-pin I/O only

Tbl. 16: Default settings: menu [ADVANCED]

Graph screen: graph parameters	Choice - Setting limit
High decade	-11 – +6 -3 ¹⁾
Low decade	-12 – +5 -7 ¹⁾
Display Time	12 s – 1 h 0.5 s ¹⁾
Auto scale	Enabled Disabled ¹⁾
Auto scale size	2 decades ¹⁾ 4 decades
Sampling time	100 ms – 30 0.5 s ¹⁾
Enable record	Enabled ¹⁾ Disabled
1) Default setting	

Tbl. 17: Default settings: graph parameters

Certificate



Certificate no.

CU 72181190 01

License Holder:
Pfeiffer Vacuum SAS
98 Avenue de Brogny
74009 Annecy
France

Manufacturing Plant:
Pfeiffer Vacuum SAS
98 Avenue de Brogny
74009 Annecy
France

Test report no.: USA- 31881465 001

Client Reference: Julien Coulomb

Tested to: UL 61010-1:2012 R4.16

CAN/CSA-C22.2 NO. 61010-1-12 + GI1 + GI2 (R2017)

Certified Product: Leak Detector

License Fee - Units

Model Designation: ASM 306 S

7

Rated Voltage: AC 100-240 V 50/60 Hz

Rated Power: 300 W

Protection Class: I

Appendix: 1, 1-11

7

Licensed Test mark:



Date of Issue

(day/mo/yr)

18/10/2018

TÜV Rheinland of North America, Inc., 12 Commerce Road, Newton, CT 06470, Tel (203) 426-0888 Fax (203) 426-4009

10/2011 02 18 © TÜV, TÜV and TÜV are registered trademarks. Utilization and application requires prior approval.

Declaration of conformity

We hereby declare that the product mentioned below complies with all the applicable provisions of the following **EC directives**:

- **Machinery 2006/42/EC (Annex II, no. 1 A)**
- **Basse tension 2014/35/CE**
- **Electromagnetic compatibility 2014/30/EU**
- **Restriction of the use of certain hazardous substances 2011/65/EU**
- **Waste of Electrical and Electronic Equipment 2012/19/EU**

The person responsible for compiling the technical file is Mr. Arnaud Favre, Pfeiffer Vacuum SAS, 98, avenue de Brogny B.P. 2069, 74009 Annecy cedex.

**Leak detector
ASM 306S**

Harmonized standards and national standards and specifications applied:

French standard NF EN 61010-1: 2011

French standard NF EN 61326-1: 2013

French standard NF EN 60204-1: 2006

French standard NF EN 50581: 2013

Signature:



Pfeiffer Vacuum SAS
98, avenue de Brogny
74009 Annecy cedex
France
B.P. 2069

Arnaud Favre
Product Group Director Instrumentation and Systems
Pfeiffer Vacuum SAS

02/20/2020





VACUUM SOLUTIONS FROM A SINGLE SOURCE

Pfeiffer Vacuum stands for innovative and custom vacuum solutions worldwide, technological perfection, competent advice and reliable service.

COMPLETE RANGE OF PRODUCTS

From a single component to complex systems:

We are the only supplier of vacuum technology that provides a complete product portfolio.

COMPETENCE IN THEORY AND PRACTICE

Benefit from our know-how and our portfolio of training opportunities!

We support you with your plant layout and provide first-class on-site service worldwide.

Ec04 - Date 2023/02 - P/N:1274430EN



Are you looking for a
perfect vacuum solution?
Please contact us

Pfeiffer Vacuum GmbH
Headquarters • Germany
T +49 6441 802-0
info@pfeiffer-vacuum.de

www.pfeiffer-vacuum.com